



SCIENTIFIC RESEARCH OF THE SCO COUNTRIES: SYNERGY AND INTEGRATION

上合组织国家的科学研究：协同和一体化

Materials of the
International Conference

Date:
July 12

Beijing, China 2019

上合组织国家的科学研究：协同和一体化
国际会议

参与者的英文报告

International Conference
“Scientific research of the SCO
countries: synergy and integration”

Part 1: Participants' reports in English

2019年7月12日，中国北京
July 12, 2019. Beijing, PRC

ISBN 978-5-905695-42-1



Materials of the International Conference
**“Scientific research of the SCO countries: synergy
and integration”** - Reports in English

(July 12, 2019. Beijing, PRC)

ISBN 978-5-905695-42-1

这些会议文结合了会议的材料 – 研究论文和科学工作者的论文报告。它考察了职业化人格的技术和社会学问题。一些文章涉及人格职业化研究问题的理论和方法论方法和原则。

作者对所引用的出版物，事实，数字，引用，统计数据，专有名称和其他信息的准确性负责

These Conference Proceedings combine materials of the conference – research papers and thesis reports of scientific workers. They examines tecnical and sociological issues of research issues. Some articles deal with theoretical and methodological approaches and principles of research questions of personality professionalization.

Authors are responsible for the accuracy of cited publications, facts, figures, quotations, statistics, proper names and other information.



ISBN 978-5-905695-42-1

©Scientific publishing house Infinity, 2019

© Group of authors, 2019

CONTENT

ECONOMICS

数字化转型条件下EAEU工程产业合作发展的管理方法论形成

The management methodology formation for the industrial cooperation development of the EAEU engineering industry in the conditions of digital transformation

Belyakova Galina Yakovlevna, Fokina Darya Aleksandrovna.....9

国内外水资源再利用及其治理

Water Reuse and Its Regulation in Russia and Abroad

Yerzncyan Bagrat Haykovich, Fontana Karine Arkadievna.....16

PEDAGOGICAL SCIENCES

大学生信息能力培养的方法创新

Methodical innovations for the development of information competence of university students

Tabachuk Natalia Petrovna.....24

SOCIOLOGICAL SCIENCES

在伏尔加格勒地区为残疾人创造无障碍环境

Creating of a barrier-free Environment for People with Disabilities in the Volgograd region

Skobelina Natalia Anatolyevna.....29

向下楼梯：垂直无能。关于俄罗斯联邦公共行政现状的思考

Up the down staircase: vertical incompetence. Reflections on the current state of public administration in the Russian Federation

Lopukhin Vladimir Yurievich.....34

PHILOLOGY

19世纪下半叶戏剧艺术的特点和A. P. 契诃夫戏剧创作在国内文学评论家中的表现
Features of dramatic art of the II half of the 19th century and innovation of plays of A.P. Chekhov in representation of domestic literary critics

Novikova Albina Alekseevna.....39

ART HISTORY

写作嘉庚文的特点。中国书法出现的先决条件

Features of writing jiaguwen. Prerequisites for the emergence of Chinese calligraphy

Chaikovskaia Aleksandra Vladimirovna, Zhang Mingzi.....47

MEDICAL SCIENCES

改进的Open Field测试协议执行

Modified protocol of the Open Field test performing

Kravchenko Sergey Vladimirovich, Kade Azamat Khalidovich,

Kazanichi Dzhanetta Nurbieva.....55

TECHNICAL SCIENCE

解决模糊文本重复检测问题的一种方法

One way to solve the problem of fuzzy text duplicates detection

Sharapova Ekaterina Viktorovna.....59

解决血细胞图像上的白细胞分类任务

Solving leukocytes classification task on blood cell images

Chernykh Evgeniy Mikhailovich, Soynikova Ekaterina Sergeevna,

Mikhelev Vladimir Mikhailovich.....65

PHYSICS AND MATHEMATICS

环境，光和重力波。假设和建议

Environment, light and gravity waves. Hypotheses and suggestions

Sumachev Yury Nikolaevich.....72

Foreword

We thank all participants of our conference "Scientific research of the SCO countries: synergy and integration" for the interest shown, for your speeches and reports. Such a wide range of participants, representing all the countries that are members of the Shanghai Cooperation Organization, speaks about the necessity and importance of this event. The reports of the participants cover a wide range of topical scientific problems and our joint interaction will contribute to the further development of both theoretical and applied modern scientific research by scientists from different countries. The result of the conference was the participation of 56 authors from 7 countries (China, Russia, Uzbekistan, Kazakhstan, Azerbaijan, Tajikistan, Kyrgyzstan).

This conference was a result of the serious interest of the world academic community, the state authorities of China and the Chinese Communist Party to preserve and strengthen international cooperation in the field of science. We also thank our Russian partner Infinity Publishing House for assistance in organizing the conference, preparing and publishing the conference proceedings in Chinese Part and English Part.

I hope that the collection of this conference will be useful to a wide range of readers. It will help to consider issues, that would interest the public, under a new point of view. It will also allow to find contacts among scientists of common interests.

Fan Fukuan,

Chairman of the organizing committee of the conference

"Scientific research of the SCO countries: synergy and integration"

Full Professor, Doctor of Economic Sciences

前言

我们感谢所有参加本次会议的“上海合作组织国家的科学研究：协同作用和整合”，感谢您的演讲和报告。代表所有上海合作组织成员国的广泛参与者都谈到此次活动的必要性和重要性。参与者的报告涵盖了广泛的主题性科学问题，我们的联合互动将有助于不同国家的科学家进一步发展理论和应用的现代科学研究。会议结果是来自7个国家（中国，俄罗斯，乌兹别克斯坦，哈萨克斯坦，阿塞拜疆，塔吉克斯坦，吉尔吉斯斯坦）的83位作者的参与。

这次会议的召开，是学术界，中国国家权力机关和中国共产党对维护和加强科学领域国际合作的高度重视的结果。我们还要感谢我们的俄罗斯合作伙伴无限出版社协助组织会议，准备和发布中英文会议文集。

我希望会议的收集对广大读者有用，将有助于在新的观点下为读者提供有趣的问题，并且还将允许在共同利益的科学家中寻找联系。

范福宽，
教授，经济科学博士，中国科学院院士，会议组委会主席“上合组织国家科学研究：协同与融合”

数字化转型条件下EAEU工程产业合作发展的管理方法论形成
**THE MANAGEMENT METHODOLOGY FORMATION
FOR THE INDUSTRIAL COOPERATION DEVELOPMENT
OF THE EAEU ENGINEERING INDUSTRY IN THE CONDITIONS
OF DIGITAL TRANSFORMATION**

Belyakova Galina Yakovlevna

*Doctor of Economic Sciences, Full Professor
Department of Economics and Business Process Management
Institute of Business Processes and Economics
Siberian Federal University
Krasnoyarsk, Russia*

Fokina Darya Aleksandrovna

*Candidate of Economic Sciences, Associate Professor
Department of Customs Registration
Institute of Civil Aviation and Customs Registration Reshetnev
Siberian State University of Science and Technology
Krasnoyarsk, Russia*

抽象。具有复杂的层级管理结构的集体管理实体使工业合作开发管理变得复杂。这种复杂情况在EAEU机器制造企业中很常见，其中许多企业具有多级管理系统结构。同时，在多层次系统中存在特殊性 - 有必要解决功能，权力和责任分配的任务。该研究的重点是在数字化转型的背景下，形成一种管理欧亚经济联盟工程行业产业合作发展的新方法。

关键词：管理方法；工业合作；工业合作模式；数字合作生产；欧亚工业合作。

Abstract. *The industrial cooperation development management is complicated by collective management entities having a complex hierarchical management structure. This complication is common for the EAEU machine-building enterprises, many of which have a multi-level management system structure. At the same time, in multilevel systems there is specificity - it is necessary to solve the tasks of the distribution of functions, powers and responsibilities. The research is focused on the formation of a new methodology for managing the development of industrial cooperation for the engineering industry of the Eurasian Economic Union in the context of digital transformation.*

Keywords: *Management methodology; industrial cooperation; models of the industrial cooperation; digital cooperative production; Eurasian industrial cooperation.*

The management of the system of industrial cooperation aimed at interconnected, but formally separate enterprises of the engineering industry, which are sometimes at a considerable distance from each other, has its own characteristics. On the one hand, the managed object is a collective one — a group of enterprises and it is necessary to take into account and predict the interaction within this group. On the other hand, the subject of management can also be collective - management decisions affecting the same managed enterprise system can be made by several subjects, each of which may, for example, affect certain components of the managed object's activities (technology, resource provision, organization of sales activities). These features raise the problem of coordinating the interests of objects of management and ensuring the conditions for their effective interaction. Some models of coordination of decisions of subjects of management are considered in the works of D. Novikov, for example, "Theory of management of organizational systems" [1].

The methodology formation for the industrial cooperation development in the engineering industry has specific features, including the uniqueness and unpredictability of human activity in specific conditions, including limited capabilities and resources, the ability to adapt to changing conditions, the ability to organize and develop. Management of the industrial cooperation development of the engineering industry has the following features:

- Subjectivity- it is the personal qualities of the subjects of management, their professional experience and ethical position play an essential role.

- Independent goal determination - the subjects independently formulate not only the goal of their activity and the ways of achieving it, but also the goal of the activity of the controlled system, decomposing them into tasks.

- Indirect result - the impact is carried out in order to ensure the desired behavior of the controlled system, the final (indirect) result is the state (the result of the activity) of the controlled system.

- Creative nature - the decision-making process cannot be formalized, there are always uncertain factors, elements of creativity regulated by legal, ethical and other norms, "tightness" of resources and other constraints.

- The necessity for modeling (foresight, prediction of the behavior of the controlled system depending on the control actions). The managerial decisions making process is to work out a certain solution in each specific situation.

Considering that the management of the development of industrial cooperation is a complex and multitasking process, the approaches to its implementation are also distinguished by their multiplicity and multidimensionality. The main goal of

managing the development of industrial cooperation is to ensure the coordinated interaction of all participants in the cooperation system, synchronization of plans and high speed of management decision-making to achieve goals [2]. To manage industrial cooperation, first of all, it is necessary to use elements of a systems approach based on consideration of the subjects of the cooperation chain as a set of interrelated elements that have common goals [3]. In a systematic approach to management, the following principles should be observed:

- a decision-making process should begin from the identification and clear formulation of specific goals;
- identifications and analysis of possible alternative ways to achieve the goal;
- goals of individual subjects should not conflict with the goals of the whole system;
- an unity of analysis and synthesis of the logical and historical;
- manifestation in the object of different connections and interactions.

Managing the development of industrial cooperation uses elements of a program-target approach based on the development of programs for the optimal achievement of goals, taking into account the limited resources necessary for their implementation. In formulating goals, despite the independent goal-setting of subjects of cooperation, a generalized goal of the system arises. At each stage of management, the strategic goal is subdivided for priorities tasks are highlighted, which based on material, time and other resources.

The machine-building enterprises have gained considerable experience in applying the program-target approach, but changes in the external environment and the development of technologies lead to the emergence of new managerial tasks based on the objective need to organize production within the framework of cooperative interaction, which have to be solved together with enterprises of the system of industrial cooperation.

For effective management of the development of industrial cooperation, it is proposed to use a methodology containing elements of a program-targeted and systemic approach. The proposed methodology is based on the integrated use of end-to-end ITC - technologies combined into a single information-analytical environment, information technology platform (ITP) [4]. This technique, through the use of modern management tools, can be called the method of managing industrial cooperation of enterprises using ITP.

In order to achieve the defined aim of this research, the authors used the system analysis method, studied the statistical data, including the reports of the United Nations Conference on Trade and Development [5] and the World Bank's ratings [6]. The authors took into account the prerequisites in the creation of the Eurasian Economic Union, analyzed the current economic situation in its Member States, and considered the experience of other regional alliances. According to the results

of the research, the authors formulated the new approach for the management methodology for the industrial cooperation development of the EAEU engineering industry in the conditions of digital transformation. The developed management methodology for industrial cooperation provides the following tasks:

- assessment of resource potentials and the formation of production orders and plans for all participants in the system of industrial cooperation;
- identification and evaluation of bottlenecks in the planning of production throughout the system of cooperation in real time;
- optimization of capacity utilization at the same time at the enterprises of the cooperation system;
- monitoring the state of production and supporting processes for all manufactured products at all levels of cooperation in real time.

Solving those tasks it is necessary to use advanced digital instruments, for example, the use of management model "Digital cooperative production". "Digital cooperative production" as the name of the model of management of industrial cooperation of enterprises based on the digital presentation of information about processes and objects should have the following main steps:

- Formation of the resource model of the network of industrial cooperation enterprises and transformation of this model digital space.
- Formation of a digital model of technological supply chains of components and raw materials for all participants of industrial cooperation system.
- Analysis and ranking of production risks for all participants in the cooperation process.
- Formation of schedules for mutual deliveries of industrial cooperation enterprises
- Combining production plans and schedules of all enterprises of industrial cooperation in a single digital system.
- Analysis of the status of planned orders throughout the network of industrial cooperation
- Comparison of the obtained results with planned indicators, assessment of identified deviations [7].

Management of industrial cooperation of machine-building enterprises, each of which is a separate economic system, on the one hand, has the ability to develop within the enterprise itself; on the other hand, it is characterized by a significant dependence on the influence of mixed factors. In Fig.1 highlighted the factors asked by external to the engineering industry environment. When describing the activities of a managed object:

- modern standards and requirements for engineering products;
- changes in the architecture of the world engineering market;
- transformation of the engineering industry.

Invariant for management activities are the blocks of tools that are being formed to counteract environmental factors: motivational, personnel, material, technical, scientific, methodical, financial, organizational, regulatory and legal.

The method of managing the development of industrial cooperation of enterprises based on the use of ITP has the following main steps:

Stage 1. Formation of a unified information technology platform of the system of enterprises participating in industrial cooperation:

1. Formation of the resource model of the system of industrial cooperation and the transformation of this model into digital space.
2. Formation of a digital model of technological supply chains of components and raw materials for all participants in the industrial cooperation system.
3. Analysis and ranking of production risks for all participants in the cooperation process.

Stage 2. The solution of information and analytical problems arising during the implementation of the production and technological process:

4. Formation of schedules of mutual deliveries of enterprises within the system of industrial cooperation.
5. Combining production plans and schedules of all enterprises of industrial cooperation into a single digital system using ITP.

Stage 3. Automated monitoring of the execution of planned targets throughout the entire system of enterprises for industrial cooperation

6. Analysis of the status of planned orders throughout the system of industrial cooperation
7. Comparison of the obtained results with planned indicators, assessment of identified deviations.

Managing the development of industrial cooperation of enterprises of the engineering industry is a backbone activity that combines individual blocks of tools into a single system and ensures the achievement of intended results. The peculiarity of this technique is the transition from recording and visualizing data to solving information and analytical tasks in order to increase the effectiveness of management decisions and automated control of their execution. The role of management is to transform all available resources: labor, information, technology, production into a coherent community that can ensure the realization of the goals set, so that the interests of the owners, investors and staff of the enterprises are satisfied, as well as use various blocks of tools to ensure the achievement of the planned results.

In the conditions of continuous changes in the external environment, for the effective management of high-tech, diversified industries, it is necessary to increase the flexibility and versatility of management.

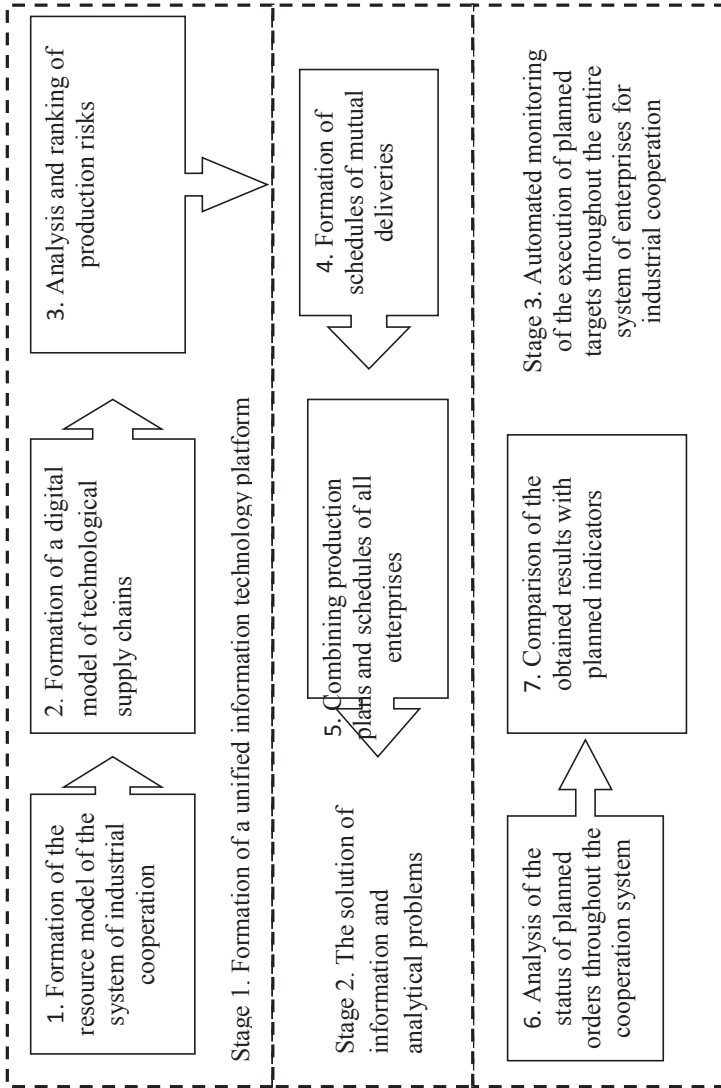

Fig. 1. The management methodology for the industrial cooperation development of the EAEU engineering industry based on ITP

References

1. D. Novokov. *Theory of management of organizational systems. 2nd edition.* - Moscow: Fizmatlit, 2007.
2. G. Belykov; G. Belykova & D. Fokina. *Formation of models of industrial cooperation management of machine-building enterprises in the transition to a digital manufacturing // IOP Publishing/ IOP Conf. Series: Materials Science and Engineering 537 (2019) 042034*
doi:10.1088/1757-899X/537/4/042034
3. Laszlo & Krippner. *Systems Theories: Their Origins, Foundations, and Development/ J.S. Jordan (Ed.), Systems Theories and A Priori Aspects of Perception.* Amsterdam: Elsevier Science, 1998. Ch. 3.
4. Sun, Gregor & Keating. *Information Technology Platforms: Definition and Research Directions/Australasian Conference on Information Systems/ Adelaide IT-Platforms: Concept & Review, 2015.*
5. *Trade and Development Report 2018 - Power, Platforms and The Free Trade Delusion (UNCTAD/TDR/2018)*
6. *World Bank (IBRD) Management's Discussion & Analysis (MD&A) and Financial Statements / <http://pubdocs.worldbank.org/en/900341542646251905/IBRD-Sep-18.pdf>*
7. G. Belykov; S. Belykov; V. Lyachin; T. Zelenskaya; D. Fokina. *Creation of value chains and cooperation of machine builders within the Eurasian Economic Union // Revista ESPACIOS. ISSN 0798 1015 Vol. 39 (N° 04). 2018*

国内外水资源再利用及其治理

WATER REUSE AND ITS REGULATION IN RUSSIA AND ABROAD

Yerznkyan Bagrat Haykovich

Doctor of Economic Sciences, Full Professor

Head of Laboratory

Fontana Karine Arkadievna

Candidate of Economic Sciences, Senior Researcher

*Central Economics and Mathematics Institute of Russian Academy
of Sciences (CEMI RAS)*

抽象。 本文的目的是研究与处理后废水再利用相关的问题,包括对其重复使用的国际立法框架的概述。 结果表明,经过处理的废水再利用的实践是水资源可持续发展的重要因素,也是缓解水资源压力和解决环境问题的有效途径,可以弥补全球气候变化对城市生态系统的负面影响。 讨论了水再利用的一些特征,作为限制区域中可能的替代水源之一。 值得注意的是,有许多国家缺乏规范水资源再利用的正式制度(游戏规则),虽然缺乏部分由非正式制度(传统规范)填补,但正式规制中的要求仍然是实际的。

关键词: 水资源, 处理后废水, 直接再利用, 调节。

Abstract. *The purpose of this paper is to examine issues related to the reuse of treated wastewater, including an overview of international legislative framework regulating its reuse. It is shown that the practice of reusing treated wastewater is an important element for the sustainable development of water resources and an effective way to mitigate water stress and to solve environmental problems, compensating the negative impact of global climate change on urban ecosystems. Some features of regulation of water reuse as one of the possible alternative water sources in regions where they are limited are discussed. It is remarkable that there are lots of countries where formal institutions (rules of game) regulating the reuse of water are absent, and although their absence is filled in partly by informal institutions (traditional norms), a requirement in the formal regulation remains actual still.*

Keywords: *water resources, treated wastewater, direct reuse, regulation.*

JEL Classification Codes: A12, O32, P52.

1. Introduction

In the face of increasing demand on water resources and strengthen water stress, one of the important directions of water policy is to provide the sustainability of water resources, development of measures to reduce existing and prevention the projected pressure on them to achieve a satisfactory state of natural water resources as well as ensuring continuous access of population to high-quality water.

Among such measures, you can highlight the increasing water-use efficiency, reducing leakage in water distribution networks and water reuse, which is an important element of circular economy, water quality management tool and environment protection, due to restrictions on the dumping of sewage and water abstraction from natural water sources.

Speaking on the reuse of water we have in mind above all its use in the city limits after cleaning of the households, and possibly, businesses and organizations. For clarity, we will give some definitions of this kind of water.

Water reuse is the use of water based on purified wastewater, especially in the urban area. Wastewater is cleaned before reaching a certain quality that is appropriate for its further use in limited applications, taking account of the legislation and the potential risks to human health and the environment.

Urban (municipal) wastewater is domestic waste water or the mixture of domestic waste water with industrial, located within the city limits and having common stock. Urban and industrial wastewater has different characteristics (e.g., on the content of organic matter, pathogens, heavy metals, etc.) that affect the way they clean for reuse.

Direct reuse refers to the supply of treated wastewater to the consumer using an appropriate infrastructure, in particular a dedicated pipeline. Indirect reuse refers to the collection of water from natural sources for subsequent use, where the discharge of (partially) treated effluents was previously carried out. Planned reuse refers to systems organized for the supply and use of treated wastewater that has been treated in accordance with its further use. Unplanned reuse means the out-of-control repeated use of effluents after their hit in natural reservoirs. For example, consumers "below down stream" use water from the river in that an up-cast comes true higher down stream.

This paper refers mainly to the planned direct reuse of treated wastewater and its regulation. In an urban economy, the wastewater reuse provides achievement of a lot of goals. For example, watering of green plantations (parks, street lawns, golf-grounds, wayside green stripes) with the use of wastewater reuse is widely widespread in the USA, Israel, Latin America, Australia, Mediterranean and Arabic countries, North Africa and India.

In cities, water resources effective management can create a basis for their sustainable development towards both *smart* and *water wise cities* which combine greater productivity and innovative potential with lesser costs and the impact on environment (Yerznkyan, Fontana, 2018).

2. Principles of Water Reuse Regulation

The basic concept of wastewater reuse was formulated by UN Economic and Social Council in 1958, under which the water of high quality shall not, unless it has in abundance, to be used for the purposes that allow use of water of lower quality.

Over the past 100 years the consumption of fresh water in the world has grown in 2 times – this growth has overtaken population growth. Scientists believe that increased consumption of fresh water will continue to occur mainly due to: population growth; changes in the diet of the population and the increase in water consumption per person (in the world today, one person consumes an average of 2 times more than in 1900); the development of tourism (e.g., tourists in Grenada (Spain) use on average 7 times more water than locals; in Israel, water use by hotels along the river Jordan, believed to have caused the drying up of the Dead sea, where the water level since 1977, fell by 16.4 m); growth of water consumption from the industry (annually in the world for domestic, industrial and agricultural water supply consumes about 4,000 km³/year); growth of energy consumption.

Experts suggest that if the existing approach to the use and reuse of water resources, by 2030 the gap between the need for fresh water and its range can reach 40% (2030 WRG). Therefore, there is every reason to believe that water reuse in the near future will expand.

Wastewater must be seen not as a waste, from which you want to get rid of, but as a resource, which may be an important element in the sustainable management of water resources and become an important lever in solving freshwater shortages, mitigate the effects of climate change, have beneficial effects on the environment (Fontana, Fontana, 2016).

We will add also, that from the technical point of view the water reuse is a part of decision of the problems, related to the water-supply and water control. However technically feasible projects will not be realized from institutional, legal, economic and organizational barriers, bad perception of public, exhaustive quality and quantitative null data. These non-technical barriers are limitation for expansion of planning and adjusting of the water reuse, and they need in regulative documents.

3. Water Reuse Regulation

There are not unified rules and leading principles of treated wastewater reuse regulation – neither world nor European. Taking into account the cultural and institutional differences of countries, to prepare single rules appears an insoluble task. As J.Stiglitz claims, “countries need to consider the alternatives and, through democratic political processes, make these choices for themselves. It should be – and it should have been – the task of the international economic institutions to provide the countries the wherewithal to make these *informed* choices on their own, with an understanding of the consequences and risks of each” (Stiglitz, 2002, p. 88).

Another example: the differences between China and India are not only in culture, but also in terms of doing business and making foreign investments (Yerznkyan et al., 2017, p. 74). As to some similarities between these two neighboring countries, they are as follows: in both countries the economic success is based on implementation of large-scale process of reforms, which are constantly under review by the government; both use a five-year plan as a framework of economic policy and designing of reforms; both employ economic instruments, e.g. attraction of Foreign Direct Investment (FDI) through fiscal incentive, to increase country competitiveness; both countries created free trade zones to accommodate foreign investments: Special Economic Zones in China and Export Processing Zones in India; the governments of both countries are willing to tackle the regional development problem and related issues to provide sustainable economic growth (ibid., p. 75).

It is remarkable that from 1978 up to now, China has enjoyed average economic growth of roughly 10% a year, just like Japan has over the earlier three decades, i.e. from the mid-1950s to the mid-1970s. As to Russia, the reforms much more recent – in the 1990s – can be used to compare with those of China to cover the spectrum of institutional change and cultural evolution, though “we still are a long way from having any neat models of cultural evolution” (North, 1990, p. 44).

So, difficulties are explained by institutional distinctions between countries: “Western civilizations with their inherent two-valued logic of thinking and the dominance of open access orders in society are more prone to economic exchanges – transactions, while Eastern civilizations, with their multi-valued logic and limited access orders, on the contrary, are more prone to social exchange processes – interactions.... We emphasize that in this context the concepts of the West and the East are rather conditional: their features can be evident in Russia as well, which is characterized by a high degree of regional differentiation and, additionally, an individual-personal one” (Yerznkyan, Gassner, 2018, p. 134).

Nevertheless, within the framework of the countries included in one or another regional union (member states of EU, SCO, etc.), preparation of more or less single regulative documents fully can be carried out.

To understand the modern system of water resources management in Russia, it makes sense to highlight briefly the similar systems of the Soviet period. In the USSR, for water treatment were used methods that were well shown themselves, including from the point of view of capital investments in sewage treatment plants and their subsequent exploitation, and also positive influence on chemical composition and agro-melioration properties of irrigable soils, productivity of rural economy cultures. The similar systems and practices were recommended to wide introduction in practice of agricultures production, but however in future wide distribution of treated wastewater reuse did not get.

In Russia, in spite of the fact that in "Water strategy of Russian Federation on a period till 2020" is indicated, that the increase of rationality of water consumption is arrived at by the decline of losses of water at transporting, reduction of specific consumption of water in technological processes, on service-utility needs, and the last is arrived at by "expansion of the use of the circulating and repeatedly-successive water systems", wastewater is used mainly in industry or thrown down in natural reservoirs.

Unfortunately, in practice water is counted not as the main resource of life-support of population, but as the expense material. Water reuse of effluents is not examined in a number priority at the decision of ecological and socio-economic tasks, and also as an important element of steady development of water resources neither in Water strategy of Russian Federation on a period till 2020, nor in Strategy of ecological safety of Russian Federation on a period till 2025, nor in other legislative acts.

At the same time, at an international level more than thirty legislative acts are accepted, and in their development participated such organizations, as the UNO, OECD, World bank, etc. Many of these documents do not have analogues in the Russian legal field. A situation is complicated by that "in the conditions of realization in regard to RF of politics of inhibition, the threat of access to foreign environmentally clean innovations, technologies, materials and equipment restriction is formed" (Strategy..., 2025, point 23).

According to the rules and norms accepted in RF, all effluents (before their up-cast in reservoirs) must be cleared to the level of *maximum to the possible concentration* and *approximately safe levels of influence* corresponding to the up-cast in the reservoirs and currents, intended for the economic-drinkable, cultural and welfare or fishing industry setting.

Afterwards, for providing of population by drinking-water and satisfaction of urban and rural economies' needs, water is perched from natural water sources, including reservoirs, where earlier an up-cast came true. Thus, for consumers "below down stream" we look after "unplanned indirect water reuse", that officially does not confess authorities, and the population is not informed of it.

Let us now compare now Russian experience with such of European Union countries. There are a variety of directives of the European Parliament and of the Council concerning wastewater treatment and related issues:

- Directive 91/271/EEC of 21 May 1991 concerning urban wastewater treatment. Official Journal. L 135/40, 30 May 1991.
- Directive 91/676/EEC of 12 December 1991 concerning the protection of waters against pollution caused by nitrates from agricultural sources. Official Journal. L 375/1, 31 December 1991.
- Directive 98/83/EC of 12 December 2006 on the quality of water intended for human consumption. Official Journal. L 330/32, 5 December 1998.

- Directive 2000/60/EC of 23 October 2000 establishing a framework for community action in the field of water policy. Official Journal. L 327, 22 December 2000.
- Directive 2006/7/EC of 15 February 2006 concerning the management of bathing water quality and repealing Directive 76/160/EEC. Official Journal. L 64/37, 4 March 2006.
- Directive 2006/118/EC of 12 December 2006 on the protection of groundwater against pollution and deterioration. Official Journal. L 372/19, 27 December 2006.
- Directive 92/43/EEC of 21 May 1992 on the conservation of natural habitats and the wild fauna and flora. Official Journal. L 206, 22 July 1992.
- Directive 2009/147/EC of 30 November 2009 on the conservation of wild birds. Official Journal. L 20/7, 26 January 2010.
- Directive 2006/44/EC of 6 September 2006 on the quality of fresh waters needing protection or improvement in order to support fish life. Official Journal. L 264/20, 25 September 2006.
- Directive 2006/113/EC of 12 December 2006 on the quality required of shellfish waters. Official Journal. L 376/14, 27 December 2006.

However, these directives are used partially. From the point of view of presence of formal institutions, regulating the treated wastewater reuse, EC countries can be subdivided into:

- countries with the leading principles (Cyprus, Germany, Greece, France, Italy, Portugal, Spain, UK);
- countries, where these principles are used fragmentary (Belgium, Hungary, Latvia, Netherlands);
- countries, where these principles are in the stage of development or consideration (Bulgaria, Malta, Poland);
- countries, where the leading principles are absent (Austria, Denmark, Ireland, Lithuania, Luxemburg, Romania, Slovakia, Slovenia, Finland, Czech Republic, Sweden, Estonia).

In countries (and not only European), where formal institutions (regulative directives) are absent or present partly, efficiency of the water reuse is arrived at due to the presence of informal practices, e.g. such as processes of collection and processing of data in cities. A good example is the platform of Boston City Score (<https://www.boston.gov/cityscore>) – online-instrument that accumulates data and municipal information reflecting efficiency of Boston as a city and its management system. Corresponding reports for the past day, week, month and quarter, so that everybody could to become familiar with actual information on management efficiency, are published on the city's web-site. Similar platforms are realized also in Los Angeles, New York and Houston. Their success demonstrates growing tendency to introduction of "management methods on basis of data", implying maximal use of data to increase the municipal economy's management efficiency and inform the habitants of results of realization of one or another decisions (Yerzknyan, Fontana, 2019, p. 861).

4. Conclusion

Water resources, including the wastewater reuse, being one of basic resources, necessary for the vital functions of man, capable to become one of key factors of sustainable development of a socio-economic system, in particular municipal economy. Their use supposes support on innovations, digital technologies and effective management on the basis of possibilities, given by a circular economy. The last term serves for denotation a special type of economy being based on the use of renewable resources and contrasted in this sense to the traditional, linear economy, based on creation, use, and order by them.

One of major directions of a circular economy for water is the wastewater reuse. Similar practices are used in the industrially developed countries of the world, but in Russia run into the row of difficulties. Among them: absence of stimuli to introduction of innovative technologies and methods of water-supply; inadequate to the local terms and technological decisions institutional providing reuse of effluents; weak tying up conducted by the municipal city) governments of power of politics with the creature of certain problems of wastewater reuse, etc.

The purpose of the study in this paper was an attempt to attract attention to the importance of rational water use through the water reusing practices and corresponding regulation taking into account the specificity of countries involved in this process. Moreover, countries are at different stages of the development of domestic legislation on water reuse, the global nature of supply chains and food market, population mobility and tourism development, and also due to the fact that both pure and recycled fraction (in this case water) can move freely across borders – has an impact not only on the competitive position of producers from various countries, but generally on economic and social situation of countries on the background of increasing global water crisis.

The practice of reusing treated wastewater is an important element for the sustainable development of water resources. A relevant water management system, equipped with an information system that is free from major shortcomings, i.e. a closed nature and a focus on “internal use”. In this case, the management system will be able not only to overcome the crisis of water resources, but also to switch to their reuse, and in the future – to the formation of a circular economy in the field of water resources.

However, a lack of uniform global guidelines and rules governing the reuse of wastewater, including methods and generally accepted levels of wastewater treatment, based on the further use in specific applications (including the possibility to adapt to specific local conditions) is a significant deterrent to the expansion of water reuse practices. In addition, a lack of clear policies that defines: wastewater reuse as part of water resources; legal and institutional framework for the implementation of such projects; financial resources; introduction of modern technolo-

gies; environmental risks; the lack of reliable quantitative and qualitative data, non-organized and often not available for public consultation, are also limiting factors of treated wastewater reuse.

The results of this study can be used by state authorities and local (municipal) self-government, executive structures in the management of water complex; in scientific research related to water supply and wastewater, in the solution of environmental issues.

References

1. 2030 WRG [online link]. Available from: <https://www.2030wrg.org/> (accessed on 15.03.2018).
2. Fontana, K.A., Fontana, C. (2016). *Wastewater Use: A New Opportunity for the Green Economy. General overview, Actual Problems of Humanitarian and Natural Sciences*, 3, March, Part II: .8–11 (in Russ.).
3. North, D.C. (1990). *Institutions, Institutional Change and Economic Performance*. Cambridge: Cambridge University Press.
4. Stiglitz, J.E. (2002) *Globalization and Its Discontents*. London: Allen Lane. The Penguin Press.
5. *Strategy of ecological safety of Russian Federation on a period till 2025*.
6. Yerznkyan, B.H., Fontana, K.A. (2018). *Institutional Aspects of the Circular Economy's Development in the Sphere of Water Supply*. Herald of CEMI RAS, 1 [Electronic resource]. Access for registered users. URL: <http://cemi.jes.su/s1111111000079-9-1> (circulation date: 21.11.2018) (in Russ.).
7. Yerznkyan, B.H., Fontana, K.A. (2019). *Efficiency of Urban Water Resource Management and Its Evaluation*. *Economic Analysis: Theory and Practice*, 18, 5: 855–876 (in Russ.).
8. Yerznkyan, B., Gassner, L. (2018). *Cultural and Institutional Differences at the National and Regional Levels*. *International Journal of Economics, Finance and Management Sciences*, 6, 4: 133–138.
9. Yerznkyan, B., Gassner, L., Kara, A. (2017). *Culture, Institutions, and Economic Performance*. *Montenegrin Journal of Economics*, 13, 2: 71–80.

大学生信息能力培养的方法创新

METHODICAL INNOVATIONS FOR THE DEVELOPMENT OF INFORMATION COMPETENCE OF UNIVERSITY STUDENTS

Tabachuk Natalia Petrovna

*Candidate of Pedagogical Sciences, Associate Professor
Associate Professor of the Department
of Mathematics and Information Technologies
Pacific State University*

注解。 本文讨论了“教育创新”，“教育创新”，“教学创新”，“有条理创新”概念的定义方法，这些概念与社会的数字化转型有关，反过来影响了社会的性格和口音。 学生信息能力高中的发展。 在分析这些方法并考虑到教育数字化的基础上，文章强调大学生信息能力发展的方法论创新是三个相互关联的组成部分的复合体；有针对性，有意义的，组织活动，基于现代 新范式和教育目标。

关键词：教育创新，教育创新，教学创新，有条理创新，数字化转型，大学生信息能力。

Annotation. *The article discusses approaches to the definition of the concepts “innovation in education”, “pedagogical innovation”, “didactic innovation”, “methodical innovation”, which are connected with the digital transformation of society, which in turn influenced the character and accents in the development of students' information competence high school. Based on the analysis of these approaches and taking into account the digitalization of education, the article emphasizes that methodological innovations for the development of information competence of university students are a complex of three interrelated components: targeted, meaningful, organizational-activity, based on modern new paradigm and educational goals.*

Key words: *innovation in education, pedagogical innovation, didactic innovation, methodical innovation, digital transformation, information competence of university students.*

At present, in the modern conditions of the emergence of the digital society, digital transformation of education is taking place, new national projects and programs are emerging (Education, Science, Digital Economy of the Russian Federation, Modern Digital Education Environment, Open Education [6]), aimed at the implementation of modern new paradigms and goals of education. In the Federal State Standards of Higher Education at the present stage, there is a focus on the

competence approach in expanding the content and organization of the educational process at the university.

Competence-based approach is described in the works of modern domestic and foreign scientists (J. Raven, S.G. Vorovshchikov, I.A. Zimnyaya, V.V. Kraevsky, A.V. Khutorsky, etc.), which emphasize its focus on student comprehension acquired subjective experience, its assessment, interactive interaction of all participants in the educational process and coordination of their values [3, 4, 5, 13, 14]. In previous studies, we noted that the competence-based approach in education is not opposed to knowledge, but complements it, has a metasubjective nature and suggests the relevance of the personal meanings of subjects in the educational process [11, 12].

At the same time, it is important to implement this approach in education today in a conglomerate with the platform approach described in the research of A.I. Ageeva, M.A. Averyanova, S.N. Evtushenko, E.Yu. Kochetova [1]. They note that the platform approach to the formation of a digital society implies two aspects: organizational and technical. If we extrapolate the material described in the research of these scientists, it can be argued that within the organizational aspect, the platform in the educational process can be viewed as a communication platform, on the basis of which the subjects of the digital educational space begin to build their relationships through information interactions within the ecosystem. Within the technical aspect, the platform can be considered as a set of components (infrastructure and application) that allow the above-mentioned participants to implement interactions and services [1]. The platform approach in education is an organizational and technical innovation that provides digital transformation of education as the development of new information and communication infrastructure supporting the implementation of modern paradigms and goals of education.

It is these approaches that are the theoretical basis for the description and implementation of methodological innovations for the development of the information competence of university students.

The term methodical innovation is found in a number of dissertation research of recent years. So, in the logic of the study of T.V. Smoleusova, the following approach to the definition of the phenomenon “methodical innovation” is traced: “innovation”, “innovation in education”, “pedagogical innovation”: “didactic innovation” and “methodical innovation”. We are close to the position of the author. Following T.V. Smoleusova, we note the unsettled nature of the concept of “innovation” [10]. Innovations in education as a pedagogical phenomenon are revealed in the works of such scholars as V.A. Slastenin, I.F. Isaev, A.I. Mishchenko, E.N. Shiyarov et al. [7]. Innovations in education for our research are promising innovations that positively affect the implementation of modern paradigms and goals of education.

As noted by T.V. Smoleusov, pedagogical innovations are a complex of didactic and methodical innovations. Didactic innovations (ideas, principles, approaches, concepts) are a means to achieve new education goals. Methodological innovations (changes in the content, methods, forms, means, technologies, techniques, tasks) are a means of introducing didactic innovations and the realization of modern paradigms and goals of education [10].

For our research, methodical innovations for the development of information competence of university students will be understood as demanded, new, effective and implemented content, forms, methods, technologies and means ensuring a high level of development of students' information competence demanded in modern conditions of digital society formation. On this basis, methodological innovations for the development of information competence of university students are a complex of three interrelated components: targeted, meaningful, organizational-activity, based on modern new paradigm and educational goals. Let's build a cycle of innovative transformations for the development of information competence of university students.

O.V. Bondarenko gives an example of the unfolding of the cycle of innovative transformations:

- a source of innovation
- innovative offer
- activities (technology) for the implementation of innovations,
- innovation process
- a new type or new form of social practice [2].

We extrapolate this material to the source of our research. And then, considering the methodological innovations for the development of information competence of university students, let us highlight the cycles of their occurrence and implementation:

- a source of innovation - the digital transformation of society and education;
- innovative proposal - methodical innovations for the development of information competence of university students;
- activities (technology) for the implementation of innovations - the introduction of methodological innovations for the development of the information competence of students at the university in the modern conditions of the development of the digital society and the translation of teaching experience at the international level;
- innovation process (forms and methods of rooting innovation in practice)
- an experimental platform on the basis of the "Pacific State University" for the implementation of methodological innovations for the development of students' information competence;
- a new type or new form of social practice - a concept for the development of information competence of university students in the conditions of modern tendencies of digital society formation as a new type of educational practice.

The described cycle of innovative transformations is a chain of causal relationships that emphasize the relevance of the study, a description of the implementation technology and the result of experimental activity.

Let us describe in more detail the methodological innovations for the development of information competence of university students as a complex of three interrelated components: targeted, meaningful, organizational-activity.

The target component is associated with the social order, “competency order”, one of which is informational.

Content component. We emphasize that modern content involves not so much the development of subject knowledge, as the development of competencies that are adequate to the modern conditions of the formation of digital society. This content should be well structured and presented in the form of platforms that serve as communication platforms for information interaction between the subjects of the educational process.

The organizational and activity component assumes the use of modern innovative teaching methods - active methods for developing competencies based on the interaction of students and their acquisition of personal meanings and subject experience in the development of information competence. When choosing teaching methods, it is important to consider the following current trends in education: a focus on defining methodological recommendations on self-development of the information competence of an individual, increasing the proportion of independent work, raising awareness, individual educational vectors, developing research skills. Following L.M. Semenova enumerate modern innovative technologies that can be used to develop students' informational competence: a lecture – press conference, modular technology, business games, case technologies, a “success map” [9].

A modern training infrastructure should include information, technological, organizational and communication components, which make it possible to effectively use the advantages of distance technologies and platforms for the development of information competence of university students.

Thus, in the modern conditions of the formation of the digital society, it is necessary to pay attention to the introduction of methodological innovations for the development of information competence of university students. The theoretical basis for the implementation of these methodological innovations are competency-based and platform approaches implemented in the field of higher education. Methodological innovations for the development of information competence of university students should be introduced on the basis of new, effective forms, methods, technologies and tools that ensure a high level of development of students' information competence, demanded in modern conditions of digital society.

References

1. Ageev A.I., Averyanov M.A., Evtushenko S.N., Kochetova E.Yu. *Digital Society: Architecture, Principles, Vision // Economic Strategies*. - 2017. - № 1. - P. 114–125. - URL: http://www.inesnet.ru/wp-content/mag_archive/2017_01/es2017-01-114-126_Ageev_Averyanov_Yevtushenko_Kochetova.pdf (access date: 10.07.2019).
2. Bondarenko O.V. *Modern innovative technologies in education // Electronic journal "RONO"*. - Issue 16 (September 2012). - URL: https://www.sites.google.com/a/shko.la/ejrono_1/vypuski-zurnala/vypusk-16-sentabr-2012 (access date: 07/10/2019).
3. Vorovshchikov S.G. *Educational and cognitive competence of high school students: managerial aspect: monograph*. - Moscow: APK and PPRO, 2006. - 232 p.
4. Zimnyaya I.A. *Key competencies as an effective target basis of a competence-based approach in education*. - Moscow, 2004.
5. Kraevsky V.V. *General principles of pedagogy: studies. allowance for stud. higher ped. studies. institutions*. - Moscow: Publishing Center "Academy", 2005. - 256 p.
6. *National projects of Russia*. - URL: <http://government.ru/rugovclassifier/section/2641/> (appeal date: 07/10/2019).
7. *Pedagogy: textbook for students of pedagogical educational institutions / V.A. Slastenin, I.F. Isaev, A.I. Mishchenko, E.N. Shiyarov*. - Moscow: School-Press, 1997. - p. 271 - 290.
8. Equal J. *Pedagogical testing: problems, errors, perspectives / translation from eng. 2nd ed., Rev.* - Moscow: Kgitto Center, 2001. - 142 p.
9. Semenova L.M. *Approaches and Methods for the Development of Motivation in University Practice // Engineering Education*. - 2013. - № 13. - p. 78–83. - URL: http://aeer.ru/files/io/m13/art_13.pdf (appeal date: 07/10/2019).
10. Smoleusova T.V. *Methodical innovations for system updating of an elementary mathematical education: abstract of the dissertation of the doctor of pedagogical sciences: 13.00.02*. - Moscow, 2017. - 40 p.
11. Tabachuk N.P. *Information competence of the student's personality as a socio-cultural phenomenon of the digital society: a monograph*. - Khabarovsk: Pacific Publishing House state University, 2019. - 180 p.
12. Tabachuk N.P. *Development of the information competence of students in educational process of a liberal arts college: dissertation of the candidate of pedagogical sciences: 13.00.01*. - Khabarovsk, 2009. - 217 p.
13. Khutorskoy A.V. *Key competencies as a component of the personality-oriented educational paradigm // Public Education*. - 2003. - № 2. - p. 58–64.
14. Khutorskoy A.V. *Key competencies. Design technologies // Public education*. - 2003. - № 5. - p. 55–61

在伏尔加格勒地区为残疾人创造无障碍环境
**CREATING OF A BARRIER-FREE ENVIRONMENT FOR PEOPLE
WITH DISABILITIES IN THE VOLGOGRAD REGION***

Skobelina Natalia Anatolyevna

Doctor of Sociological Sciences,

Head of the Department of Social Technologies

Volgograd State University

注解。近年来，伏尔加格勒地区开创了新技术，旨在为残疾人创造一个无障碍空间。残疾人和残疾人在城市空间的安全流动，融入社会，积极参与公共生活，都需要一个无障碍的环境。本文介绍了残疾人和残疾人无障碍空间的模型。

关键词：残疾人，无障碍环境，新技术，模式

***Annotation.** In recent years, new technologies have been created in the Volgograd region, aimed at creating a barrier-free space for people with disabilities. An accessible environment is necessary for the safe movement of persons with disabilities and people with disabilities in the urban space, for their integration into society, for active participation in public life. The article presents a model of a barrier-free space for persons with disabilities and disabled people.*

***Keywords:** persons with disabilities, accessible environment, new technologies, model*

Creating a barrier-free space is a public good and is associated with the socio-economic and political development of the modern Russian state. In the Volgograd region, more than 7% of the inhabitants of the region are disabled. Therefore, it can be said that the relevance of solving the problem of forming an accessible environment for persons with disabilities in the region is due to its scale, difficult economic, social and demographic situation. Currently (June 2019), 174,586 people with disabilities live in the Volgograd Region. Among them, men are 79,244 people, women - 95,342 people. The first group has 20,017 people, the second group - 77 843 people, the third group - 76 726 people [1]. Analysis of legislative and regulatory acts of state authorities of the Russian Federation, statistical information about the subjects of the barrier-free space for persons with disabilities in

*The article was supported by the grant of the Russian Foundation for Basic Research (RFBR project No. 18-413-342004) “Technologies of SO NPOs in the conditions of forming an accessible environment for people with disabilities in the Volgograd region”.

the modern society led to the conclusion that the state is the main subject in the process of forming an accessible environment. However, in a market economy, it does not cope with the problem of ensuring accessibility due to insufficient funds for the development of this sphere. Therefore, identifying entities that are actively involved in the process of forming an accessible environment in the region, along with the authorities, should be distinguished and public institutions, and economic, information practices, and business structures.

In the Volgograd region an action plan is being implemented to increase the values of accessibility indicators for facilities and services for persons with disabilities for the period from 2016 to 2030. In 2017, the state program of the Volgograd region “Social support and protection of the population of the Volgograd region” was approved, within the framework of which the subprogram “Formation of an accessible living environment for the disabled and people with limited mobility” is being implemented [2].

Volgograd region belongs to one of the regions to which, since 2014, a subsidy from the federal budget has been allocated to co-finance expenditures on the implementation of measures in the field of ensuring the availability of priority facilities and services in priority areas of the disabled and other people with limited mobility (2014-2017 - 184370, 8 thousand rubles). The total amount of financing of the subprogramme is 108535.3 thousand rubles. As a result of the implementation of measures to adapt priority objects, by the end of 2018, 927 objects were adapted, which is 68% of the total number of social, transport and engineering infrastructure objects.

The need for an accessible environment is due to the desire to improve the living conditions of people with disabilities, the ability to safely move people with disabilities in the city and in the countryside, and their inclusion in active life. The regional and municipal legislation defines the main areas for ensuring accessibility of facilities and services in various areas of life of persons with disabilities and other limited mobility groups: rehabilitation of people with disabilities in medical rehabilitation centers, implementation of social rehabilitation in public institutions, development of affordable transport infrastructure, including Taxi. In the urban space of Volgograd, technologies developed and applied in the field of employment and social support for people with disabilities and disabled people are being introduced. As a result, new technologies have been created, aimed at creating a barrier-free space. Technologies are developed by both government agencies and socially-oriented non-profit organizations. The region has opened rental offices of equipment necessary for people with disabilities, created specialized websites on the Internet, and volunteer practices are developing. Much attention is paid to the adaptation of social and transport infrastructure. The specifics of young

people as an age group, many modern youth problems have led to the creation of innovative technologies that promote the involvement of young people with disabilities in the socio-economic and cultural life of society. New technologies in the system of physical culture are aimed at promoting the adaptation of persons with disabilities in the urban space through physical culture and sports. In the information society, a large role is played by information and communication technologies, the creation of a remote form of the provision of rehabilitation services for people with disabilities.

In social service organizations under the jurisdiction of the Committee for Social Protection of the Population of the Volgograd Region, a remote form of rehabilitation services is used. The information and telecommunication network the Internet is used, transport services are provided to the disabled and to the disabled children by the “Social Taxi” services located in the territories of Volgograd, Volzhsky, Kamyshin and Kamyshinsky district, Mikhaylovka and Mikhailovsky district, Uryupinsk and Uryupinsky district, Zhirnovsky and Kotovsky regions. These services are used by disabled people of groups I and II with disorders of the musculoskeletal system and children with disabilities. Persons with disabilities and disabled people use the transport infrastructure.

For example, in 2018 429 people used transport services. In order to provide additional support to people with disabilities under the regional program, measures are being taken to provide disabled people with technical means of rehabilitation, and rental centers with specialized equipment are organized. For 2018, 315 TMRs were issued [3].

Another factor influences the formation of an accessible environment in the region and the introduction of new technologies to create the optimal social environment for people with disabilities and disabled people. Volgograd region participates in the project “The system of long-term care for the elderly and disabled”. New technologies in the social service system contribute to the formation of regional accessible space for all categories of the population. Since 2018, during the introduction of the system of long-term care for the elderly and disabled in the Volgograd region, an innovative vector of development of social services has emerged: the introduction of hospital-replacing forms of care, followed by the residence of the elderly and the disabled, the development of new forms of education - the training of relatives in need, training multipliers, which will continue to train relatives of families; the creation of comfortable living conditions for people with disabilities, the use of the brigade method of social work, the use of technology to care for seriously ill patients. Important are the technologies developed and applied in the field of employment and social support for persons with disabilities.

Thus, in recent years, a model of a barrier-free space for people with disabilities and people with disabilities has been actively created in the region. The regional and municipal legislation defines the main directions for ensuring the availability of facilities and services in various areas of life of persons with disabilities and other handicapped groups: rehabilitation and habilitation of people with disabilities in medical rehabilitation centers, the implementation of social rehabilitation in public institutions, the development of affordable transport, social, innovation infrastructure. The model of an accessible environment includes, as institutional (formal and informal practices that are created in the process of forming accessible space in the region) [4], medical (practices of identifying and caring for the elderly and the disabled), moral (ethical, inclusive) practices), information (communication practices, Internet sites, the media), legal (formal norms and rules governing relations between the subjects of an accessible environment) components, and the socio-economic component. The socio-economic component of an accessible environment implies the development of an accessible transport infrastructure, the material security of institutions for creating a barrier-free environment, projects, grants from NCO NGOs and state structures. In the model of a barrier-free environment, partner practices play a special role - forms of interaction between state and non-state institutions. For example, the development of a regional public-private partnership as a set of formal practices and informal contracts for the joint use of material and non-material resources of society and the private sector to create an accessible environment, provide social services for people with disabilities and disabled people.

At present, a three-sector interaction model is developing in the Volgograd Region: the state-business-society. Despite the fact that the work on the formation of an accessible living environment for people with disabilities and people with disabilities in the Volgograd region has been going on for several years, because of its versatility and complex scale, it remains in demand and relevant. In this regard, it is necessary to carry out long-term activities, build partnerships, ensure effective interagency cooperation of all levels of government and public institutions, as well as attracting various sources of funding, not only the federal budget.

References

1. *The Federal Register of Disabled Persons // Pension Fund of the Russian Federation.* URL: <https://sfri.ru/analitika/chislennost/chislennost?territory=1> (Appeal Date: June 24, 2019)
2. *Resolution of the Administration of the Volgograd region. from 25.09.2017 N 504-p “On approval of the state program of the Volgograd region “Social support and protection of the population of the Volgograd region” (ed. from 12.28.2018) // URL: <http://docs.cntd.ru/document/450347736> (Appeal Date: June 21, 2019).*
3. *Resolution of the Government of the Volgograd region. of 12.08.2013 N 389-p “On the Procedure for providing disabled persons with technical means of rehabilitation at the expense of the regional budget” (ed. 08/14/2017) // URL: <http://docs.cntd.ru/document/460270491> (Appeal Date: 06/21/2019).*
4. *Skobelina N.A., Fetisova A.V. Institutional aspects of the formation of an accessible environment for persons with disabilities and persons with disabilities in the Volgograd region // Sociodynamics. 2019. № 3. p. 8-12.*

向下楼梯*: 垂直无能
关于俄罗斯联邦公共行政现状的思考

UP THE DOWN STAIRCASE: VERTICAL INCOMPETENCE
REFLECTIONS ON THE CURRENT STATE OF PUBLIC
ADMINISTRATION IN THE RUSSIAN FEDERATION**

Lopukhin Vladimir Yurievich

*Doctor of Sociological Sciences, Professor
Russia, Saratov*

抽象。一段时间以来,俄罗斯的权力垂直已成为该国社会经济体系发展的主要障碍之一。阻碍民主社会中的“社会流通渠道”,正如俄罗斯所宣称的那样,导致停滞和不可避免的社会动荡。90年代掠夺国家的被宠坏的后代实际上继承了权力,再加上社会电梯,其中高层次的权力是由愚蠢的年轻女性招募的,唯一“有用”的财产是愿意支持“合适的人”的公司 - 不会带来好处。

关键词: 电力垂直; 社会竞争; 精英; 精英权利暴力; 社会流动理论; 社交电梯; 权力和金钱; 社会正义; 高档化; 社会环境“为了自己”; 蓬巴杜夫人的影响

Abstract. *For some time now, the vertical of power in Russia has become one of the main obstacles to the development of the socio-economic system of the country. Blocking the "channels of social circulation»in a democratic society, as Russia declares itself, leads to stagnation and inevitable social upheaval. The actual inheritance of power by the spoiled offspring of those who plundered the country in the 90s, coupled with a moulage of social elevators, in which the high echelons of power are recruited by foolish young women, the only "useful»property of which is the willingness to support the company of "the right people»-will not bring to good.*

Keywords: *vertical of power; social competition; elite; right of elite to violence; theory of social mobility; social elevators; power and money; social justice; gentrification; social environment "for own"; effect of Madame Pompadour*

Such a carefully nurtured vertical of power in Russia has for some time become one of the main obstacles to the development of the socio-economic system of the country.

Theoretically, the elite (the ruling "enlightened minority") in a democratic society is a product and consequence of social competition. Because of this selection, the elite should be a relatively stable set of the most worthy citizens. Without delv-

**"Up the Down Staircase" (Pan Books, 1964) is a novel by American author Bel Kaufman (Bella Koifman)/10 05 1911- 25 ahhh/07.2014 (103 years)/

ing into the theory of elites, we agree with Plato that the persons ranked among the elite, implies a higher intelligence, knowledge, abilities and competencies, superior to the average characteristic of most actors of a particular society. By J. Locke (1632 – 1704) thanks to the presence of special ["excellent"] qualities, the elite directs the development of society. And getting something from it, society] the appropriate authority, the elite manages the current activities of the company. Thus, according to the informal agreement of public consent, the society allows the right of the elite to some violence against themselves [I,494] Recall: any overcoming of the inertia of the object is violence. But excessive violence inevitably leads to incorrect actions of the managed object. Sometimes – catastrophic, teaches us physics. But back to the problems of sociology.

Modern society is a complex structured object, one way or another is a pyramid. Each upper layer (stratum) of the social pyramid is numerically smaller (the «enlightened minority "mentioned above) than the lower ones. In the explicit (and especially implicit) behavior of the subjects of economic action of any of the strata, one can clearly see the motive to restrain the influx of actors from lower strata into their strata. Including migrants from less developed societies. Fear of losing the advantage of their social position and the desire to transfer this advantage by inheritance realize the trend of a certain stagnation that hinders the development of society. To overcome stagnant trends in society, as an alternative to the "democracy of the axe and the rope". Pitirim Sorokin proposed the evolutionary theory of social mobility [II, 396]. which implies the presence of "channels of social circulation". Including, and first of all - from the bottom up. I. e. in a healthy society there should be a system of social elevators. Thanks to them (channels of social circulation), conditions are created for refreshing the "enlightened minority", to whom the society trusts the role of the elite. But with the inability (or unwillingness) of the elite to fulfill the conditions of social harmony, the refreshment of the "enlightened minority»due to the influx into it "from the bottom»of promising personnel, easily passes (as has often happened), into skinning. The history of revolutions (at least the French, though the Great Russian, for example) shows: from evisceration to anyone have the have-nots is not getting any better [III 266] .

Given the realities of the current moment in Russia, we have to say: in the period after the collapse of the Soviet Union, the "new»elite in Russian society has not developed. People who have surrounded the trough of power in dense layers, from the variety of rights and freedoms of a democratic society choose the most convenient (for the most part - vicious) options. And they did everything imaginable and unthinkable to consolidate their loved ones, descendants and just "friends»in the upper layers of the "new /old»society. Over the past three decades, a new socio-economic phenomenon has emerged: "majors". Systemic corruption generated by Nouveau riches, capital expropriated from the state (read – from people), protect

offspring from interaction with reality. In "greenhouse conditions»actually rejected from the Russian Federation "prosperity of the island»- oil and gas Lemony (from slang "lemon", as a million bucks), the generation who is well aware of the price of belonging to the ruling class grows up. And this generation of cynics literally mocks the impoverished population, throwing into the crowd packs of large bills. [IV] their turn will Come - there will be a power. And if there is no power-the money in any quantity only paper. And we see from the generation that plundered the property of the USSR, the power flows smoothly to the generation of the aforementioned "majors". By the way: «majors” do not know about social justice. Meanwhile, social justice (although mostly declared) is a fundamental value of modern liberal society. It is based on a social contract between the government and society, fraught with its violation of great violence[V, 536] But, as one well-known politician said in the past, "the process has gone.". Having seized in the period of «perestroika «unprecedented powers, aging "privatizers «transfer power to a new generation of owners. Ignorant. According to one official Pullets, diplomas of prestigious institutions have in the minds of their owners little evidence of elite education

Maturing “majors” except people "in in their circle»others don't know, don't want to know. Whole areas of cities as a result of poorly disguised gentrification are gradually forming a social environment "for their". And of these "its»pick of slaves higher "- Louts, suiting bloody “pokatushki”* "on Gelik's** and other supercars the Ferrari - Maserati). Here you have the "new footage"! As the great Griboyedov wrote, "How not to help a native person "[VI, 35] here and again come»promising «bosses, for whom the highest achievement of civilization is Wikipedia, and the source of wisdom is Instagram...). How could it be otherwise? "Too smart", [nerds "like Chatsky, if you want at best], should be»at the aunt in the wilderness in the village and grieving! [VII, 119]

The second most important factor of negative influence on governance in the Russian Federation can be called "the effect of Madame Pompadour»

Let's refresh the memory of this glorious history in quotes ladies whose name has become a household name. The Marquise de Pompadour, née Jeanne-Antoinette Poisson (1721 – 1764), was for two decades the official favorite of king Louis XV and the de facto ruler of France (the most powerful power in Europe at the time). The results of her stay between the king and France are sad and instructive. Full paralysis of the state will in favor of the whims of hysterical, insidious, power-loving, but not too smart woman, brought down the once powerful prosperous state in the second role. Many historians consider the influence of Madame Pompadour one of the main reasons for France's entry into a protracted economic and political crisis, which ultimately led to a revolutionary situation.

* Author's note: “pokatushki”*: on youth slang fashionable adventurous entertainment "Golden youth" - racing around the city with deliberate disregard for all the)

** Author's note: On “Golden youth” slang “Gelik” - Offroader's class Mercedes-Benz G-class (Geländewagen)

Sources of adaptation of this problem in domestic realities, in our opinion, it is necessary to look for in Board of "corn of all times and the people»Nikita Khrushchev. And the ever-memorable Nina Petrovna Khrushchev, respectively.

When Stalin was so-if your business is good, it does not matter with whom (and how much) you drink and with whom you sleep. Clear criteria - has performed task - get (apartments, soldering, machine, service). Also got (ten years without the right of correspondence – with the axe, felling trees, or with Kyle on "construction of communism")."Especially distinguished"(in quotes) in the NKVD vigorously "mazali lob Zelenkoy»(idiomatic expression : shot). But what social mobility was, and what elite eventually grew! One "father»of the thermonuclear bomb and the project, now known as "Poseidon", was a dissident almost from school, under Stalin (under the patronage of Beria!) became an academician. Stalin's "cleaning»of the administrative class quickly filtered the wheat from the chaff . Non-dormant «organs "instantly reacted to any rot. The risk of simultaneous treatment in the camp dust served as a powerful incentive for the official zeal of the official nomenclature.

Having won the»battle of the bulldogs under the carpet «is not an unconditional victory, Nikita needed support. And he was afraid of the «organs "mentioned above. The result was the rise of the party-Soviet nomenclature to the level of»caste "a kind of»Brahman", which owns everything, and which, accordingly, everything is allowed. Starting with the so-called "convertible salaries»(monthly payments in envelopes that are not taken into account anywhere), ending with all sorts of benefits and privileges within the Soviet system (from special distributors to personal shopping tours of official wives on special planes to Paris). And an almost total lack of control, coupled with absolute impunity. Repeatedly defeated "organs»were forbidden even to breathe in the direction of the bureaucratic caste. From the bottom. What can we say about the "inhabitants of heaven"!

Behind the collective irresponsibility, leapfrog and confusion of the "collective leadership»in the "planned management system", the inevitable consequence was a wave of legalized in fact all sorts of "adjustments»and subscriptions, which gained the force of the tsunami . What is personal responsibility? The purpose of the saw is to please the Boss. Everything else was meaningless. So "moral stability»became the only criterion of evaluation of the bureaucrat. For personal uncleanness nomenclature bureaucrat has lost everything and forever. Therefore among whores of both sexes, with all possible diligence of spies recruited all, since local commissioners

Here is a defensive reaction of the bureaucracy and formed the phenomenon of service - official prostitution. The office party (and other) items, almost openly began to recruit "special»troops. Including – "on the fan". Protected by the nomenclature immunity from the obsessive attention of "organs", cute "butterflies»of both sexes, the only pass to the privileges accompanying the authorities, was the unconditional readiness to fulfill the "quirks»corresponding to the rank of "responsible comrades". Whores have

become a kind of Annex to the post. Like an office or a car. In a poor country bossy prostitutes began to multiply as flies-fruit flies. Always ready! Day or night. Even in the open air, even in the cabin of the official cars (when properly turned away the lackey of the driver). Up to the head office. In the presence of accumulated waiting for applicants in the waiting room. Comrades (companions) "for difficult to serve people", allows the above-mentioned "responsible comrades»to do a "thing", which is where the horror came professional priestesses (and priests) of love. In breaks between execution of "informal party orders", "soldiers»and "soldiers»of the invisible [uninitiated] front, on pieces of paper read out appeals to companions-workers "to build the bright future". With high (and not very) stands. And do not forget to "selflessly fight for peace in the world."

Naturally, the criteria for selection of the type of smazlivost face and readiness for authoritative wave of the finger to strip naked, other competences from consideration fell. That's where social elevators worked to the point of exhaustion, pulling out the light of God [in power] "the most worthy"!

Scandals 90- 's with "people, similar on.»burned, but not scared.

With prostitutes – Yes, amoral. And with "comrades on party»(on work, on movement) Love? Or – friendship? Maybe... Just really tight?...

Against the background of an excess of administrative and legislative initiatives, which [initiatives] cause "misunderstanding»even in preschool children. involuntarily you think: whether mass recruitment in various power structures of nice young women is caused by similar motives? And the impenetrable stupidity of the "significant»statements of those

Power vertical? Or still, "up the stairs leading down"...?

List of information sources used

1. *J. Locke Two treatises on the Board/John Locke, translated from English. - Moscow: Society, 2017. 494 p.*

2. *Sorokin P. A. Man. Civilization. Society. / Pitirim A Sorokin Series: Thinkers of the twentieth century. M. Politizdat. 1992, 543 p.*

3. *A. T. Averchenko a Dozen knives in the back of the revolution/ Arkady Timofeevich Averchenko Reprint of the original edition (published by "Publishing house University Library", 1921), Moscow: RUGRAM POD, Book on Demand, 2018 266 p.*

4. *https://twitter.com/y_rus96 Anonymous with the mask stretched from the car window a packet of notes thousandths on the Nevsky Prospekt in St. Petersburg / (accessed: 15.03.2019).*

5. *Rolls J.A theory of justice/John Rolls Monograph. Trans. from English. Ed.3 Lenand, 2017. 536 p.*

6. *Griboyedov A. Woe from wit/Atticus 2012 256 p. 35.*

19世纪下半叶戏剧艺术的特点和A.P.契诃夫戏剧创作在国内文学评论家中的表现

**FEATURES OF DRAMATIC ART OF THE II HALF OF THE
19TH CENTURY AND INNOVATION OF PLAYS OF A.P. CHEKHOV
IN REPRESENTATION OF DOMESTIC LITERARY CRITICS**

Novikova Albina Alekseevna

*Candidate of Philological Sciences, Associate Professor
Branch of the Far Eastern Federal University
in Ussuriysk (School of Pedagogy)*

注解。 文章讨论了A.P. Chekhov对戏剧艺术的考虑的各种方法，突出了研究他的戏剧的主要时期，给出了作家戏剧作品特征的传统和新观点； 揭示了20世纪下半叶至21世纪初文学评论家的态度。 至于人和创造力A.P.契诃夫。

关键词： A.P. 契诃夫； 作者的研究人员； 不同的观点和观点；戏剧； 传统与创新。

Annotation. *The article discusses various approaches to the consideration of the dramatic art by A.P. Chekhov, highlights the main periods of studying his plays, gives traditional and new points of view on the features of the writer's dramatic works; reveals the attitude of literary critics of the second half of the 20th - early 21st centuries. as to the person, and creativity A.P. Chekhov.*

Keywords: *A.P. Chekhov; researchers of the writer; different views and points of view; dramaturgy; tradition and innovation.*

Anton Pavlovich Chekhov (1806-1904) - a writer and playwright who entered literature in the eighties of the nineteenth century, into the literary environment in which his unique work was made. He was endowed with a special gift that distinguished him from the great writers, his predecessors and contemporaries A.S. Pushkin, N.V. Gogol, F.M. Dostoevsky, A.N. Ostrovsky, M.E. Saltykov-Shchedrin, I.S. Turgenev, L.N. Tolstoy. The importance of Chekhov, of course, cannot be measured solely by his comments, however meaningful they may be. Not only in the depths of creativity, but also in the peculiarities of time, answers to the questions should be found: what is this "Chekhov's enlightened despair", "the wisdom of his everydayness", "the quiet infinity of his faith in progress"? These questions were repeatedly asked by the researchers of A.P. Chekhov, not only during the twentieth century, they continue to excite scientists and now.

It is known that A.P. Chekhov left the traditions of A.S. Pushkin and N.V. Gogol, but the main reason for the writer's worldwide recognition is in Chekhov

himself. The circle of acquaintance of the reader with his work, the problematics of "Chekhov studies" is extremely wide, in this connection we limit ourselves to considering the main literary sources about the artist's words and single out the individual topics being studied and the main problems of historical and literary nature. Today, there is no doubt the irreplaceable role of these studies in the school and university education systems, designed not only to develop and enhance the thinking of students, but also to instill in them spiritual values, moral, ethical and aesthetic ideas, which gives Russian classical literature in general.

In the works of the 1970s-90s, far from completing the study of A. P. Chekhov's dramatic heritage, there is a great interest of literary critics to Chekhov's plays. Considering the originality of his works, the researchers supplemented the material of their predecessors with new observations on the characters of the characters and the artistic originality of the writer's prose and dramaturgy. It is in the growing attention of scientists to the works of A.P. Chekhov, aimed at identifying the spiritual and moral understanding of his work, we see the relevance of our article. The focus of literary science is still the processes of self-identity, especially their manifestations in the plays of A.P. Chekhov, in particular, in "The Cherry Orchard." Hence, the goal of our study is to consider the emergence in the Russian literary studies of new trends and trends in the study of the drama of A.P. Chekhov.

Note that the small stories of Chekhov had a great influence on the work of writers of the late XIX - early XX centuries. He was an innovator not only in small prose at the turn of the century, continuing the realistic traditions of the classics of Russian literature, but also had a strong influence on the development of drama in general, especially one of his main plays, The Cherry Orchard, which he wrote in 1903. In it, the author focused on the description of the everyday life of the Russian intelligentsia, the formation of a female character, the position of the Russian nobility, reflecting the typical social situation in Russia of that time.

Among a large number of researchers in the work of Chekhov, V.V. Ermilov, A.F. Zakharkin, G.A. Byaly, L.P. Gromov, A.I. Revyakin, M.L. Semanova, A.P. Chudakov, G.P. Berdnikov, V.B. Kataev and others [9]. Their works have accumulated vast biographical material, described the writer's life course, compiled a chronology of his heritage, reviewed many of the problems of ideological and artistic growth and his creative connections with great Russian and foreign writers.

On the peculiarities of the drama of Chekhov wrote V. B. Kataev, A.B. Esin, V.V. Ermilov, A.P. Chudakov, M.M. Dunayev et al. Let us dwell on some of the authors' works and single out the main problems that they studied. Of particular interest are the works of G.P. Berdnikov. In the monograph "Chekhov-playwright. Traditions and innovation" (1957) a researcher analyzing the originality of the writer's dramatic works ("The Cherry Orchard", "The Seagull", "Uncle Vanya") examines the psychological state of the characters, believing that their social po-

sition in society and the individual in life are linked to Chekhov together [2]. In his other work, "A.I. Chekhov. Ideological and creative searches "(1984) G.I. Berdnikov draws his attention to the fact that the heroes of Chekhov's plays are "spokesmen for the moods of their time" [1].

Close to his statements about the social significance of the plays by A.P. Chekhov V. V. Ermilov (Chekhov's Dramaturgy, 1967), who pointed to a very important feature of the writer's drama - the "simplicity and everydayness of the portrayed", which "not only did not interfere, but, on the contrary, helped A.P. Chekhov to raise the most important questions of his time "[5, p. 34].

V.B. Kataev paid attention to this feature (Chekhov's Literary Relations, 1989), emphasizing that the playwright in his plays "always is on the side of advanced people who disagree with modern depraved reality (for example, Petya Trofimov "The Cherry Orchard")" [6]. A.P. Chudakov, exploring the problem of psychologization of the heroes of Chekhov's early works, emphasized the "role of overtones creating diversification and "undercurrents" in the writer's dramatic works ("Psychologizing the Image of the Early Chekhov ", 1974) [10].

The study of the play by A.P. Chekhov's "Cherry Orchard" is dedicated to the works of A.I. Revyakina (Chekhov's Creativity, Moscow, 1956), A.P. Skaftymova ("The moral search of Russian writers (articles on Chekhov)", 1972). The comprehension of the genre nature of the play "The Cherry Orchard" was performed by the well-known "Chekhov" by L.P. Gromov, who devoted A.P. Chekhov his work "On the genre nature of Chekhov's play" The Cherry Orchard "(1985).

At the turn of the era appeared significant work of the philologist and theologian M.M. Dunaev "Orthodoxy and Russian Literature" (Moscow, 1996), in a new way revealing the ideological positions of Chekhov and his attitude to Orthodoxy. A little later, M.L. Semanova in the book "Chekhov at School" (2001) turned to the modern school study of the play Cherry Orchard, where she considered ways of interpreting the play in literature classes in secondary school [7].

It is known that at the end of the 19th century, society was disappointed in the former ideals, the level of spirituality and morality declined, which was also reflected in literature (prose, poetry, dramaturgy). Aware of these problems, Russian literature undertook to solve them in its own way, urging readers to improve themselves and to grow spiritually. The most striking and distinctive figures in the drama of the second half of the XIX century are A. N. Ostrovsky, L. N. Tolstoy, A. P. Chekhov. It was under their influence that all major themes developed in dramatic works. In a new way, they revealed the ideas of spiritual good and development that are above the vulgar modernity. The incarnation of artistic images in the plays of Russian dramatists is mainly connected with these trends.

So, in the plays of A. N. Ostrovsky much attention is focused on female characters. The author's attention is riveted on the tragic, full of sorrows and hard-

ships, the fate of the Russian woman, manifested in family and love conflicts. "The women of Ostrovsky's later plays," notes N.N. Skatov, "carry with them enormous energy of love, affection, and self-denial, but these gifts are not needed by anyone. Their impulses are squandered into emptiness, they themselves perish ... "[8, p.413]. A.N. Ostrovsky, in the first place, often idealizes the female image, making it emphasized that it is sublime in comparison with the male image. And dramatic collisions, secondly, are connected, according to the researcher, with the social position of his characters. Only in this "emphasized opposition to social problems of opposition" the features of Ostrovsky's characters appear most strongly.

Pointing to the dramaturgy of L.N. Tolstoy, researcher N.N. Skatov emphasized that the writer's work was "completely imbued with ideas of moral self-improvement. In his dramatic works, for example, in the drama "The Power of Darkness", capitalist soulless cruelty is contrasted with traditional family values. The play of L. Tolstoy is tendentious. It contains traditional morality. " According to the scientist, L.N. Tolstoy as a writer believes that "morality is designed to save the human person from moral poverty. Therefore, he focuses on the artistic images of Russian peasants " [8, p.416].

From a different point of view, N.N. Skatov comes to the plays by A.P. Chekhov. It is quite another matter in the drama of A.P. Chekhov, he believes. It is in the soul of an ordinary person that the idea of a positive beginning is laid. She became "innovative" in the literature of the last third of the XIX - early XX century. At the same time, many critics note that in the creation of artistic images by A. P. Chekhov manifests a dramatic beginning, revealing not only through the social status of the characters, but also through the interaction of many aspects of life, ideas, attitudes, attitudes and beliefs inherent in one or another hero. But according to the researcher, "Chekhov's drama is given mainly through the consciousness of the hero and through the atmosphere of action, woven from many random details of everyday life, behavior, mood" [8, p.414].

It can be concluded that in the Russian drama of the end of the XIX century such artistic images were performed, which by their nature were deeply realistic, and they were connected with the events of pre-reform Russia, reflecting the moral degradation characteristic of modern dramatists of society. Therefore, A.P. It was important for Chekhov to take a fresh look at this society, to some extent destroy the established traditions of A.N. Ostrovsky and L.N. Tolstoy. These features are indicated, above all, by researchers of Chekhov's creativity.

Thus, G. P. Berdnikov believes that "in his work Chekhov relied on the thoughts and aspirations of ordinary Russian people. They were representatives of the most diverse professions and classes, people very distant from the revolutionary avant-garde of the city and village, so far without any particular political

ideals, and sometimes even the very thought of any kind of struggle. These people are more and more imbued with the idea that it is impossible to continue to live like this, that life must certainly be changed”[2, p. 204 - 205].

Speaking about the originality of Chekhov's plays, which took their special place in the literary process of that period, G. P. Berdnikov emphasizes that the determining factor in A. P. Chekhov's dramatic work is the author's pessimism when looking at modern man. He does not accept a vulgar and immoral life, sometimes even to the direct denial of their way of life (“No, it's impossible to live anymore!”).

At the same time, it should be noted that the opinion of the researcher that A.P. Chekhov was characterized, on the one hand, by deep pessimism when he created his plays. This point of view was considered correct in literary criticism in the 40s – 70s of the 20th century. Today, it is impossible to agree with her, since A.P. Chekhov was still not completely disappointed in a person, many of his heroes, on the other hand, carry in their consciousness an aspiration for a brighter, better future. This, in our opinion, manifested the moral ideal of the writer himself.

One can accept the thought of G. P. Berdnikov about the “subtext” and “two-sidedness” characterizing Chekhov's drama. “The action,” the author writes, “takes place in ordinary living conditions, which generate everyday, at first glance, meaningless conversations. However, all these ordinary conversations, in addition to their first plan - the participation of heroes in external stage action, also have a second plan - turn out to be correlated with the internal world of heroes, with their main lyrical theme, constantly signaling its presence”[2, p. 137].

Note that V. B. Kataev, a well-known literary critic and researcher of A.P. Chekhov, in his monograph *Chekhov's Literary Ties* (1989), studying the prose and dramatic legacy of the great artist of the word, discovered some parallels in his work with the work of his contemporaries. The author highlighted the peculiarities of the writer's manner of A. P. Chekhov in comparison with his predecessors and followers of the playwright (Shakespeare, Goethe, A. S. Pushkin, L. N. Tolstoy).

V. B. Kataev rightly considers that the creative connections of A. P. Chekhov with classical and contemporary literature highlight the originality of the creative genius of the author of *The Cherry Orchard*. The scientist writes: “Considering the features of similarity, it is important to come to an understanding of the dissimilarity, the uniqueness of the word spoken by Chekhov. From studying relationships, in which a whole epoch is reflected, one should go to the realization that Chekhov's work survived his era and became an integral part of universal spiritual values”[6, p. 252]. Following G.P. Berdnikov critic also turns his attention to the spiritual world of Chekhov's characters, to their spiritual and moral experiences, to their place in this complex world.

At the same time, we find a new understanding of the plays of Anton Chekhov at the beginning of the nineteenth century in the studies of the famous philologist and theologian M.M. Dunaeva, who in his extensive work "Orthodoxy and Russian Literature" (2003) studied the interrelation of religion and Russian classical literature. This, in our opinion, is a new interesting look at the work of A. P. Chekhov and his dramaturgy in particular, as well as the modern approach to identifying the Orthodox worldview of the writer.

Exploring in detail the question of whether or not P. Chekhov belongs to Orthodoxy, M.M. Dunaev writes about the possible influence of religious beliefs on the ideological and figurative content of the works of the famous writer. The difficulties that arise before the researchers of the connections of A. P. Chekhov with religion, M. M. Dunaev, explains that the writer had a very complicated character and a specific mindset. It is known that A.P. Chekhov himself, being a secretive man, restrained, did not seek to express his spiritual experiences openly.

Having carefully studied the biography of A. P. Chekhov, M. M. Dunaev came to the conclusion that certain character traits inherent in the author of *The Cherry Orchard* influenced all of his work: the existence of this person, even with temporary changes in life views "[4, p. 559]. In this case, the researcher relies on the experience of his predecessors on this issue (N.O. Lossky, N.N. Berdyaev, S.N. Bulgakov and others), analyzing their points of view.

So, N.O. Lossky, according to M.M. Dunaev, without denying the humanism inherent in the writer, believed that "A. P. Chekhov was not a deeply religious person, but simply "naively believed in progress" [quote: 4, p. 558]. The Russian philosopher N. A. Berdyaev, in the understanding of the critic, always "viewed all Russian literature as an expression of Christian ideas." He believed that, in this connection, A. P. Chekhov "indirectly and indirectly retained these ideas in his work, despite the pessimistic gloom of the majority of his works" [quote: 4, p. 559].

The position of M. M. Dunaev, as he himself notes, is close to the position of another Russian philosopher, S. N. Bulgakov, who proved the religiousness of A. P. Chekhov and the world significance of the writer's artistic views. So, S. N. Bulgakov, according to the scientist, singled out the statement of A.P. Chekhov in his works of the main Christian values (good, meekness, mercy, love, search for the Divine), but "not through consideration of virtuous and highly moral types of heroes, but through the study of human vulgarity, weakness, hypocrisy, immorality, all those negative qualities, carriers which many of his heroes became" [quote 4, p. 559]. And the writer was interesting to the reader that "portraying such heroes, which serve as a kind of anti-example, the author expresses his moral and ideological disagreement with this kind of lifestyle, urging readers to moral

self-improvement". And further M. M. Dunaev writes: "Not admiring admiring of the heights of the spirit, but compassionate love for the weak and sinful, but living souls - the main pathos of Chekhov's works" [4, p. 560]. And with this statement, the scientist can not agree.

Considering the play *The Cherry Orchard*, M. M. Dunaev, for example, offers a peculiar and unconventional approach to its interpretation. He singled out in the play not a social problem, reflecting the decline of the nobility and the birth of a new bourgeois class (as is commonly believed in traditional literary criticism), but the problem of humanism. "The question of man, of man's place in being, is what the author occupies," writes the researcher [4, p. 754]. In this regard, M. M. Dunaev sees the key meaning of the final scene of the play as follows: abandoned *Firs* in the sold estate is associated with a crisis of humanism that captured all the heroes of the play. "*The man* has been forgotten!" - as if the author, according to the researcher's thoughts, speaks in this play.

Thus, we presented a new point of view of M. M. Dunaev to A. Chekhov's play *The Cherry Orchard* and we believe that his opinion differs from other researchers in its originality and originality. Important, in our opinion, is a deep understanding of M.M. Dunayev of the spiritual and humanistic tendencies in the work of the writer as a whole.

Having studied the specifics and features of the development of drama by A. N. Ostrovsky, L. N. Tolstoy and A. P. Chekhov, we identified various assessments of the interpretation by the literary scholars of A. P. Chekhov's dramatic works, in particular his play *The Cherry Orchard*. If G. P. Berdnikov, when analyzing, put forward the traditional point of view, paying attention to the social content of the work, then other researchers and M. M. Dunaev considered the play "The Cherry Orchard" in a new way. If V. B. Kataev noted the talent of the playwright, his originality and artistic originality in the disclosure of artistic images, concentrating his attention on ethical issues, then M.M. Dunaev innovatively approached the analysis of the plays of A.P. Chekhov, highlighting in them the connection of public moods with the spiritual and moral foundations of the writer's own worldview.

References

1. *Berdnikov G.P., A. P. Chekhov. Ideological and creative quest / G. P. Berdnikov. - Moscow: Education, 1984. - 231 p.*
2. *Berdnikov, G.P. Chekhov-playwright / G.P. Berdnikov. - Moscow: Art, 1957. - 398 p.*
3. *Gromov, L.P. On the genre nature of Chekhov's play The Cherry Orchard / L.P. Gromov. - Moscow: Education, 1985. - 196 p.*
4. *Dunaev, M. M. Orthodoxy and Russian Literature / M. M. Dunaev. - Part 4. - Moscow: Christian literature, 2003. - 484 p.*
5. *Ermilov V.V. Chekhov's dramaturgy / V.V. Ermilov. - Moscow: Enlightenment, 1967. - 343 p.*
6. *Kataev V. B. Chekhov's literary connections. / V. B. Kataev. - Moscow: Enlightenment, 1989. - 365 p.*
7. *Semanova M. L. Chekhov in school / M. L. Semanova. - L. : Uchpedgiz, 1954. - 371 p.*
8. *Skatov N. N. The history of Russian literature of the 19th century (second half) / N. N. Skatov. - Moscow: Education, 1991. - 512 p.*
9. *See: Byaly, G. Time and the fate of Russian writers / G. Byaly. - L., 1981. - 500 pp.; Kataev V. B. Chekhov's Prose: The Problem of Interpretation / V. B. Kataev. - Moscow: Education, 1979. - 243 p.; Revyakin A.I. Chekhov's creative work / A.I. Revyakin. - Moscow: Education, 1956. - 432 p.; Skaftymov A.P. Moral searches of Russian writers / A.P. Skaftymov. - Moscow: Enlightenment, 1972. - 455 p. ; Sukhikh I.N. Problems of the poetics of A.P. Chekhov / I.N. Sukhikh. - L., 1987. - 343 pp.; Turkov A., A.P. Chekhov and his time / A. Turkov. - Moscow, 1987. - 348 pp.; Chudakov A.P. Chekhov's World / A.P. Chudakov. - Moscow: Education, 1986. - 255 p. and etc.*
10. *Chudakov A. P. Psychology of the Image in the Early Chekhov // A. P. Chudakov. - Moscow: Enlightenment, 1974. - 201 p.*

写作嘉庚文的特点。 中国书法出现的先决条件

**FEATURES OF WRITING JIAGUWEN. PREREQUISITES
FOR THE EMERGENCE OF CHINESE CALLIGRAPHY**

Chaikovskaia Aleksandra Vladimirovna

Candidate of Economic Sciences, Associate Professor

Zhang Mingzi

Postgraduate

Saint-Petersburg State University of Industrial Technologies and Design

Nowadays, the possibility of self-expression is becoming increasingly important in society. One of the main tools that contribute to this is the costume.

The history of the costume at each stage was closely connected with the art and geographical features of certain peoples. In the modern world, the integration of ethnic motifs into clothing, as well as the use of fragments in the decor, referring to authentic art forms, is becoming a frequent phenomenon. The art of Chinese calligraphy has become one of these arts, widely spread in costume design.

Chinese calligraphy as an art form is an extensive topic that scientists from all over the world have been studying for thousands of years. Such interest contributed to the emergence of many works, books and articles on this topic, without consideration of which a full-fledged study in this area cannot be conducted.

Scientific works of various authors were chosen as literary sources, among which Russian and Chinese researchers predominate.

Calligraphy (or Chinese character calligraphy) is a unique manifestation of Chinese culture, known as: “verses without words,” “invisible dances,” “painting without pictures,” or “music without sound.”

Chinese calligraphy is the art of writing hieroglyphs, which is a rather peculiar visual art. However, this uniqueness does not prevent a person who does not know the language and writing to appreciate the art of calligraphy. Its most important element is Chinese hieroglyphs, since calligraphy originated and still develops within the culture of the country, and hieroglyphics is one of the main elements of its culture.

It is believed that Chinese calligraphy originates from the appearance of hieroglyphs, but hieroglyphs were not the first works of calligraphy.

At its core, hieroglyphs originate from drawings, and hieroglyphic inscriptions first appeared on ceramics. The first such images are only chaotic characters that do not have an exact meaning [8].

"Jiaguven" in translation from Chinese means "inscriptions on turtle shells." In addition, bovine or deer shoulder blades were also used as materials. Jiaguwen is the oldest writing system in China. It has all the elements characteristic of writing (form, sound, meaning), and is also a direct ancestor of Chinese characters that has existed since the time of the Shang state (XIV-XI centuries BC).

To this day, artifacts from animal bones or turtle shells have been preserved, which were dipped by priests in the presence of a ruler in sacrificial blood and heated by fire until they crack. Divination (the exact name is plastomancy) was carried out by studying the shape of the formed cracks. The results were applied to the bone in the form of hieroglyphs, now known as jiaguven. These inscriptions are examples of the earliest forms of Chinese writing.

The first samples of the ancient Chinese letter "jiaguven" were discovered in 1899 with more than one hundred thousand bone fragments (*Fig. 1*). On materials of various animal origin, samples of about 4,700 hieroglyphs are preserved. To date, it has been possible to decipher about 1,800 hieroglyphs, which became the fundamental material in the study of the history and culture of the Shang-Yin epoch, the periods following the history of Ancient China, and also allowed to trace the evolution of Chinese writing [7].

The main technique for making jiaguven is carving with the addition of a small amount of ink, and a sharp knife served as a writing tool, with which the text was applied to a hard tortoise shell or bone [12]. Thanks to this technique of application and the material, the jiaguven hieroglyphs have a special relief, as well as fine lines and the characteristic "harmony" of symbols.

All hieroglyphs of jiaguven consist of three elements: points, lines and angles (turns), and are divided into groups according to the method of writing.

The structure of fortunetelling inscriptions throughout all periods of development of Jiaguwen did not undergo significant changes. The inscriptions invariably included the date, the name of the predictor, the question asked, the answer to it, as well as a note on the performance of the prediction. However, the style of writing has undergone significant changes: from large and coarse forms, to subtle and elegant.

In 1991, to the east of Huayuan-chuang (花园庄/花园莊), not far from the first and main excavation site, more than 500 shells with jiaguven inscriptions were found. The value of this finding also lies in the fact that all the samples found reflect the process and the results of divination, sanctioned not by the immediate head of the Shang dynasty, but by one of the princes, which substantially complements the earlier vision of that period.

Since the invention of Jiaguwen, Chinese calligraphy fonts have experienced periods from “Zhuan” to “Lisha”, “Caoshu” and “Kaishu”, and at each stage a lot of calligraphic works have appeared, which represent ancient Chinese calligraphy traditions.

In ancient times, Chinese calligraphy was a mature art with a rich history, backed by a fundamental theoretical base. Many ancient works are a summary of the artistic practice of calligraphy, which has a great influence on the study of calligraphy and its future development.

The word "calligraphy" in the modern Chinese dictionary is interpreted as: "the art of writing" or "the art of writing hieroglyphs with a brush."

Calligraphy as an art form began its development from the southern and northern dynasties (420 - 589 BC). From the moment of the birth of the “Lishu” to the Han Wei dynasty (6 dynasties), the period of the formation and transformation of Chinese calligraphy from practice to art proceeds. Speaking of “Lishu”, it is necessary to give a description of the Qin dynasty. After the unification of the six countries, the Xiaozhuang became a common system of writing, and the “Lisha” was used as an additional one. However, it was on “Lishu” that official documents were copied to create archives. From the point of view of the history of calligraphy, Qin is a frontier dynasty, in which the use of "xiao Zhuang" marked the end of ancient Chinese writing, and the appearance of “Lishu” opened a new period of writing. After the Dongkhan dynasty came to power, the era of the formation of calligraphy as an art came. It was during this period that people notice beauty in abstract lines, feel and understand it, and also apply their vision of the beautiful in creative practice of calligraphy.

Calligraphy, made during the Wei-Jin dynasty of the North and South, occupy a very important place in the history of China. The achievements of this era are considered the first milestone in calligraphy in history. In this period significant for hieroglyphics, calligraphy has accomplished a key stage of development - the transformation of the style of “Lishu” into “Kaishu”. The value of calligraphy as an art lies in its imagery, sensuality and elegance. In its essence, it is a synthesis of the beauty of form and content, the improvement of the aesthetic component of which was continuous.

During the reign of Wei-Jin dynasty due to the development of production, as well as the increasing accumulation of material wealth, the number of educated people began to grow gradually. Calligraphy from art, accessible to a few intellectuals, began to turn into a popular and widespread form of art for all sectors of society: from the imperial general, the doctoral class and ending with folk intellectuals. Along with the advent of technologies such as copying or printing, calligraphy as an art based on inherited traditions is being improved and developed; colorful works made in various colors appear, and the Chinese art of calligraphy enters a period of prosperity.

The popularity of calligraphy in the Wei-Jin dynasty was formed for many reasons.

The first reason was the era itself. The Northern and Southern Wei-Jin dynasty is a period of social unrest and political anarchy in China. Often occurring social unrest, corruption, many wars and the sufferings of the people - all this has found an echo in the minds, and then the works of calligraphers [2].

The intelligentsia runs from reality, walking in the mountains, dramatizes what is happening in the country, spiritually striving for freedom and emancipation. Calligraphy as a work reflects their desire to express personal feelings and is gradually formed into the types of writing "lishu", "hanshu" and "caosu". This is a time of unprecedented development, the first peak in the history of China's calligraphy. Calligraphic works of Eastern Jin stand out especially against the general background. The desire for spiritual harmony, curiosity and innovation, as well as an emphasis on human emotions, helped the philosophical component of calligraphy to make a breakthrough in development.

The second reason for the growing popularity of calligraphy was the inheritance of the traditions of the Dong-Han dynasty by the Northern and Southern Wei-Jin dynasty. The style of the letter "Lishu" ceased to be official, and the Han dynasty was transferred to the "Kaishu", which later became the main one. While there was a variety in fonts, new and new works were created, and the appearance of new books contributed to the rapid growth of their circulation, and the Northern style of calligraphy began to stand out. It inherited a strict form, a tough brush and a precise manner, courageous and resolute, giving a feeling of rudeness, which corresponded to the spirit and realities of the Northern and Southern Wei-Jin dynasty, from the calligraphy of the "Lishu" of the Han dynasty.

One of the greatest representatives of calligraphers is master Wang Xizhi. Among his works, a special place is occupied by "Poems composed in the Pavilion of Orchids", "Lantingji" and "Huang Jingjiang". The second outstanding calligrapher of the era was Master Wang Xianzhi. These great calligraphers are called "two kings" due to their great contribution to the development of Chinese calligraphy [10].

The third reason for the popularization of calligraphy in China was the invention and technical improvement of paper, which provided calligraphers with easy and cheap material. The invention of cellulose paper is an important contribution of the Chinese nation to world civilization.

The ancient people wrote on bamboo slivers, because of what the letters looked awkward and were hard to read, which did not contribute to the spread of certain types of writing and artistic art. Later in China they began to use silk paper for writing. Writing on such paper was easy, but its production was too expensive, which also hampered the development of calligraphy. Thus, the invention and distribution

of paper in the shortest possible time significantly increased the education of society, and the development of calligraphy was introduced at a new level [4].

During the period of the Northern and Southern Wei-Jin dynasty, papermaking technology entered a stage of prosperity: it was possible to produce not only white, yellow or green, but also colored paper.

During the period of the Northern and Southern dynasties of Wei-Jin, a system of three exercises, “Zhushidao,” was formed, named after the first hieroglyphs in the words “Confucianism” (儒教 “Jujiao”), “Buddhism” (释教 “Shijiao”) and “Taoism” (道教 “dao jiao”), which gradually began to influence various socio-cultural aspects of life. Calligraphy and artistic creation are no exception.

During this period, the first truly great calligraphers appeared in history: Zhong Yu, Wang Xizhi and so on, and the style has undergone changes that are directly related to Taoist ideas.

During the reign of the Northern and Southern Wei-Jin dynasty, the theory of the emotional and physical component of calligraphy was more detailed and clear, had a clear vector of development. Calligrapher artists analyzed the aesthetic features of hieroglyphs from the point of view of their essence, including under the influence of the ideas of Taoism. During this period, the northern dynasty flourished, and Buddhism has a dominant position in public life, and, consequently, is the state religion, which has become an integral part of the system of government. In connection with this, a temple is being built in the city of Luoyang, as well as other temples, the number of which subsequently exceeded 1,300.

With the advent of a large number of architectural monuments (in particular, the Longmen Gate in Luoyang), ancient stone caves began to open up en masse, in which various statues and prayer records were discovered, the total number of which exceeds 10,000. In such caves, examples of texts of diverse content and artistic style were preserved, which led to the fact that Longmen Cave became a treasury of calligraphy. Following the weakening of the Confucian ideology, Laozhuang’s philosophy and teaching about Buddhism, which overcame the bonds of Confucian ideology, freed people of imposed judgment, which also created favorable conditions for East Chinese calligraphy to flourish. The weakening of the bonds of orthodox ideology and the liberation of people’s thoughts also created favorable conditions for the flourishing of Chinese calligraphy in Dongjin province. During this period, national minorities actively absorb and promote the advanced Han culture, and also contribute to greater integration of the culture of national minorities into society. The concept of aesthetic values of different nationalities interacts, penetrates each other, and even minorities feel their freedom, thereby contributing to the development of the art of the Han dynasty. At the same time, the “courageous aesthetics” of the past years continues to play a leading role in calligraphy, based on the traditional use of the brush [9].

However, the widespread use of Buddhism and Taoism affects not only the theory of calligraphy, but also many material achievements. Religion has contributed to the heyday of writing, the mass construction of temples, the expansion of the field of calligraphy, the development of a commodity economy and many other areas. At this time, the first collections of calligraphy began to appear, and certain canons of style were established, thanks to which mutual understanding was reached between recognized calligraphy masters and amateurs. This allowed us to understand more deeply the influence of calligraphy, which ultimately led to the heyday of Chinese calligraphy, the first in history.

The rapid development brought freedom of thought, suppressed over the centuries, ideas and judgments have become relevant again. Since the state is divided during this period, it cannot pursue a despotic policy based on the ideological and cultural autocracy. In addition, the people of Wei-Jin emphasize calm and restraint. It is believed that it is not permissible to openly demonstrate the joy, that a person should be able to take responsibility from a young age, and also respect the inner world of all people. This was reflected in art, that is, in its form: as part of the pursuit of aesthetics, new unusual styles of hieroglyphs and ways of designing them in rows and columns appeared in calligraphy and art.

The Northern and Southern Wei-Jin dynasty in the history of calligraphy is known for the fact that it was during this period that the “Li”, “Cao”, “Kai”, and “Shin” styles were widely used. The intense and rapid development of these styles has brought new colors to the art of calligraphy.

Calligraphic art has become extremely popular in all regions of China. Many poets sought to perfect the art of writing Chinese characters. The classic example of this period, of course, is the work "Lan Ting Xue", written by famous Chinese poet Wang Xizhi. At this time, the hieroglyphs wrote on paper, silk, fabrics, porcelain. It is then that such a trend in science as the study of the art of calligraphy appears. The first scientific treatises were written in which for the first time attempts were made to systematize calligraphic art [4].

Zhong Yu (151–230) was a Chinese politician, calligrapher, who lived during the late Han and the Three Kingdoms era.

Zhong Yu is called the "progenitor of the standard letter." At the same time, he was equally an outstanding master of handwriting "Lishu" and "Sinshi". He is also the ancestor of the “Kaishu” calligraphic style [6].

Zhong Yu combined the shape of the square with the hieroglyphs, which gave rise to smooth, straight features with a simple spelling characteristic of the popular lishu style, and then, he replaced serious and firm handwriting with light and quick features, complementing them with horizontal strokes and folding to the right. To the round features of Zhuangshu (the style of the ancient letter), a skilled calligrapher added elements of tsaoshu (the style of cursive writing). Thus, a preliminary sample of the Kaishu was created.

The best works of Chuang Yu: "Xun Shi biao" and "He Jie biao". "Xuan-shi biao" ("Memorial plate of Xuan-shi") was created by the author at the age of seventy.

The original "*Xuan shi biao*" was owned by Uncle Wang Xizhi of the famous calligrapher Wang Dao (276 - 339), who presented this masterpiece to his nephew, noting in it extraordinary abilities. Junior Wang Xizhi repeatedly copied this work by Jun Yu, written in small-format handwriting. A generation later, the original "*Xuan-shi biao*" was buried with one of the descendants of Wang Xizhi, therefore, during the Tang dynasty, it was studied only by copies of Wang Xizhi.

Zhong Yu's style was distinguished by an expressive balance of power and weightlessness of the plastic of the features, which corresponded to Wang Xizhi's own creative quest. Even taking into account the copy nature of the existing work, its high artistic level and the enormous influence that the style of Zhong Yu had on the works of the masters of the Southern dynasties of the 4th – 6th centuries are evident. In the charter of Zhong Yu, the horizontal lines ceased to sag in a wave, in which continuity with the *Lusu* proto-assembly was expressed. The ratio of the internal and external space of signs has become balanced and equitable [3].

Chinese calligraphy as an art form is an extensive topic with an extensive literary base in the form of works, books and articles on this subject, without consideration of which a full-fledged study in this area cannot be conducted.

References

1. Anashin M. "Gates to calligraphy: eight principles of the Wang Sizhi "Yun" hieroglyph" [electronic resource]. Access https://anashina.com/ieroglif-yong_public – Screen title
2. Belozerova V.G. *Spiritual Culture of China: Encyclopedia: 5 V. / Ch. ed. M.L. Titarenko; Institute of the Far East. - M.: Eastern. Lit., 2006–. Vol. 6 (optional). Art / Ed. M.L. Titarenko et al. - 2010. - 1031 p. P. 30-48.*
3. Belozerova V.G. *Spiritual Culture of China: Encyclopedia: 5 V. / Ch. ed. M.L. Titarenko; Institute of the Far East. - M.: Eastern. Lit., 2006–. Vol. 6 (optional). Art / Ed. M.L. Titarenko et al. - 2010. - 1031 p. P. 171-177.*
4. Belozerova V.G. "The Art of Chinese Calligraphy: Analysis of Cultural Tradition". *Theses in the humanities* [electronic resource]. Access <http://cheloveknauka.com/iskusstvo-kitayskoy-kalligrafii-analiz-kulturnoy-traditsii#ixzz5qGCwcM-LD>, public – Screen title

5. *Belozeroва V.G. China's history and culture: Wen Fu [electronic resource]. Access http://www.synologia.ru/a/%D0%A7%D0%B6%D1%83%D0%BD_%D0%AE, public – Screen title*
6. *Belozeroва V.G. China's history and culture: Zhong Yu [electronic resource]. Access http://www.synologia.ru/a/%D0%A7%D0%B6%D1%83%D0%BD_%D0%AE, public – Screen title*
7. *Personal Library: the period of registration and features of jiaguven. :<https://dic.academic.ru/dic.nsf/ruwiki/359482>*
8. *Lee He. Analysis of the art of jiaguwen calligraphy. Huaihua Teachers College Magazine //1993.Vol.12.No.3*
9. *Wang Shuguang. "Jiaguwen and the Art of Chinese Calligraphy." Management and Science of SMEs // 2008. (16). 82-83p.*
10. *Wang Jingzhan. "Chinese calligraphic art. Northern and Southern Wei-Jin dynasty". Cultural Relics Publishing, 1996-3.22-56p*
11. *Wang Zhengyuan. "The History of Chinese Calligraphy Theory". Shanghai Ancient Books Publishing, 2009 200-310p*
12. *Wang Yuxin. Chinese Science of Jiaguwen [M]. Shanghai: Shanghai People's Publishing House, 2009.*
13. *Xiong Bingming "The Theory System of Chinese Calligraphy". Beijing Fine Arts Publishing House / 2012-1*
14. *Jia Shuzhen, Zhang Hongbin, Chinese Jiaguwen Calligraphy, Cultural Relics, 2005.1-2-16p*
15. *Zhu Tianqi / Culture and Art Publishing House / 2009-1-1 p. 331*
16. *Cheng Xiangzhan. "" Wen Fu "and Lu Ji Literary Research." Suzhou, Suzhou University Journal, 2002*

改进的Open Field测试协议执行
**MODIFIED PROTOCOL OF THE OPEN FIELD TEST
PERFORMING**

Kravchenko Sergey Vladimirovich

Postgraduate

Kade Azamat Khalidovich

Doctor of Medical Sciences, Full Professor, Department Chair

Kazanchi Dzhanetta Nurbievna

Postgraduate

Kuban State Medical University,

Krasnodar, Russia

注解。行为测试广泛用于神经系统的研究和影响心理 - 情绪状态和认知功能的药物的临床前研究。最古老的行为测试方法之一是“开放场”方法。该测试的基础是观察在正方形或扇形中标记的封闭场地中啮齿动物的行为。这项工作的目的是修改“开放场”测试协议，用于研究啮齿动物的心理状态。

在实验过程中，使用改进的方案在“开放场”中进行40次测试，其中使用聚合物膜来确保生物介质安装的清洁度。输入测试方案“开放场”的修改允许其有效地用于评估实验室动物的行为。使用一次性可更换塑料薄膜，而不是在每次测试程序之前用清洁剂清洁装置底部，允许优化为下一次测试准备装置的过程，并消除安装中先前动物的痕迹导致的结果变形。

关键词：露天场测试，行为测试，心理情绪状态，垂直活动，横向活动

Annotation. Behavioral testing is widely used in the study of the nervous system and in preclinical studies of drugs that affect psycho-emotional status and cognitive functions. One of the oldest methods of behavioral testing is “the open field” method. The basis of this test is the observation of the behavior of rodents in an enclosed arena marked in squares or sectors. The purpose of this work was to modify the “open field” test protocol for use in studies of the psychoemotional status of rodents.

In the course of the experiment, 40 tests were conducted in an “open field” using a modified protocol, in which a polymer film was used to ensure the cleanliness of the installation of biological media. Modifications entered into the test protocol “open field” allow it to be effectively used to evaluate the behavior of laboratory animals. Using disposable replaceable plastic film, instead of cleaning the bottom of the installation with detergents before each testing procedure, allows to

optimize the process of preparing the installation for the next test and eliminates distortion of the results by traces of the previous animals in the installation.

Keywords: *open field test, behavioral testing, psycho-emotional status, vertical activity, horizontal activity*

Introduction. The open field test is one of the oldest classical methods used to study various aspects of animal behavior. It was developed by K. Hall to assess overall motor activity, exploratory behavior [1], and emotional status in rodents [2]. Its advantages include the absence of the need for preliminary training of animals, ease and high speed of implementation [2].

The most common and standard in most variants of this test is the use of the installation, representing, in various modifications, a round or square arena [3], divided into sectors (for round version), or into squares (if arena is square) of the same size [4]. The perimeter of the arena is bounded by walls that prevent the animals from escaping beyond its limits. There may be small openings in the arena floor. There are various color options for the installation, usually it is white, there are also gray and black versions - this is necessary to facilitate the software recognition of light-colored animals against the arena floor for automated computer processing. The most often used material is plastic, or any other material that does not absorb liquids and is suitable for wet cleaning, the performance of which after each examined animal is strictly necessary to obtain reliable data [2].

Depending on the goals and objectives of the experiment, various characteristics of the behavior of the animal can be recorded and evaluated. Most often, its horizontal activity — the number of squares or sectors passed by the animal, vertical activity — the number of stances on the hind limbs with and without support, the number of peeking into the holes on the arena floor (if any is used in the test version), the number of freeze reactions, shifted activity (grooming), stereotypical movements, as well as the status of the autonomic nervous system, assessed by the number of boles of defecation and the number of animal rotations performed [1, 3, 5].

Development of new variations and optimization of existing protocols for the implementation of this test continues in our time. In addition to solving specific tasks related to the adaptation of "the open field" test to the in-depth assessment of a certain factor that can influence the behavior of animals, the overall optimization of the test, aimed at accelerating the procedure of its implementation, as well as increasing the accuracy of data obtained in it, does not lose its relevance.

Purpose of work was a modification of "the open field" test protocol for use in studies of the psychoemotional status of rodents.

Materials and methods. The study was performed on 40 non-linear male rats weighing 170 ± 25 g. The animals were kept in plastic cages and were provided with free access to water and food. Keeping animals and setting up experiments were carried out in accordance with the requirements of Order №1999 of the MH of the RF of April 1, 2016, “International recommendations for conducting biomedical research using laboratory animals” (1985) and the requirements of the Geneva Convention “International Guiding Principles for Biomedical Research Involving Animals.” The criteria for excluding animals from the experiment were visible anatomical defects and signs of diseases.

Each animal passed the “open field” test, in which the standard protocol [6] was modified by the authors of this work. The installation was used with a square arena, the size of the side was 100 cm, divided by black ink into 25 squares with a side of 20 cm each. Around the perimeter, the arena of the “open field” was surrounded by boards of 40 cm height. Of the 9 central squares not bordering the installation walls, the central zone was allocated, 16 remaining squares located along the edge formed the peripheral zone. The bottom of the installation was removable and allowed to install a plastic film, which was replaced after each animal.

To perform the test, each rat was placed in the center of the arena, after which a video-fixation of its behavior was performed for 5 minutes. The following indicators were evaluated:

- the number of squares passed by each rat in the central part of the arena
- the level of horizontal activity in the center,
- the number of squares covered by the rat over the entire area of the arena
- the level of total horizontal activity,
- the number of stances on the hind legs - the level of vertical activity.

After removing the animal from the installation and placing it in the home cage, the bottom of the installation was disconnected, the film with fecal bolus and other traces of the rat's stay was removed, after which a new polymer film was placed on the bottom surface.

The obtained values of the studied characteristics of the behavior of rats were processed in the program “Statistica 12” (StatSoft Inc., USA) using descriptive statistics tools and presented in the form of a median, lower (25%) and upper (75%) quartiles (Me (Q1-Q3)).

Results and discussion. While in the arena of the installation, the rats exhibited standard behavior typical of rodents of this species under the conditions of “the open field” test. The animals moved along the walls and along the central zone, made stops, examined the angles of “the open field”, performed stances on the hind limbs with the support on the wall of the installation with the front paws and without it.

The level of total horizontal activity (the number of squares covered throughout the installation area) was 71 (56-85), the total horizontal activity (number of squares covered throughout the arena area) was 11 (8-15), the level of vertical activity was 28 (26 -33) stances on the hind limbs. In rats, there was no increased attention to the areas where there were fecal boluses and urination spots of the previous animal, which indicates reliable protection of the bottom by setting the film against the ingress of various biological media left by the rats and preventing the effect of traces of the previous animal on the next one's behavior. Using a polymer film instead of cleaning the bottom of the installation with detergents before each testing procedure allows to optimize the preparation time for testing the next animal.

Conclusions. The modifications made to the protocol of the “open field” test and the modifications tested in this study make it possible to effectively use it to evaluate the behavior of laboratory animals under novelty conditions. Using disposable replaceable plastic film, instead of cleaning the bottom of the installation with detergents before each testing procedure, allows to optimize the process of preparing the installation for the next test and eliminates distortion of the results by traces of the previous animals in the installation.

References

1. Karkishchenko V.N., Fokin Y.V., Kazakhova L.Kh., Alimkina O.V., Kasinskaya N.V. *Methods of studying the physiological functions of laboratory animals for preclinical studies in sports medicine. Biomedicine.* 2012; 4: 15-21.
2. Seibenhener M. L., Wooten M. C. *Use of the Open Field Maze to measure locomotor and anxiety-like behavior in mice //JoVE (Journal of Visualized Experiments).* – 2015. – №. 96. – P. e52434.
3. Sestakova N., Puzserova A., Kluknavsky M., Bernatova I. *Determination of motor activity and anxiety-related behaviour in rodents: methodological aspects and role of nitric oxide. Interdisciplinary Toxicology.* 2013; 6(3): 126-135. doi: 10.2478/intox-2013-0020
4. Bandelow B., Michaelis S. *Epidemiology of anxiety disorders in the 21st century. Dialogues in Clinical Neuroscience.* 2015; 17(3): 327-335. PMID: 26487813
5. Amikishieva A.V. *Behavioral phenotyping: modern methods and equipment. Bulletin of the Vavilov Society of Genetics and Breeders.* 2009; 13. 3: 529-542.
6. Khabriev P.U. *Manual on experimental (preclinical) study of new pharmacological substances. M.: Medicine, 2005. 832 P.*

解决模糊文本重复检测问题的一种方法
**ONE WAY TO SOLVE THE PROBLEM OF FUZZY TEXT
DUPLICATES DETECTION**

Sharapova Ekaterina Viktorovna

Senior Lecturer, Vladimir State University

抽象。 本文致力于解决模糊文本重复检测问题。 它讨论了完整和模糊重复检测的各种方法。 要搜索重复项，可以使用有限的文档集，也可以使用Internet上可用的整个文档空间。 为了减少在因特网上搜索的时间，建议在每页上识别一组关键句子并比较它们上的文本。

关键词：重复；文本；模糊复制；带状疱疹；搜索。

Abstract. *The paper is devoted to solving the problem of fuzzy text duplicates detection. It discusses various methods of complete and fuzzy duplicates detection. To search for duplicates, either a limited collection of documents can be used, or the entire document space available on the Internet. To reduce the time for searching on the Internet, it is proposed to identify a set of key sentences on each page and compare texts on them.*

Keywords: *duplicate; text; fuzzy duplicate; shingles; search.*

Introduction

The development of computer technology and communication tools (including the Internet) made available vast amounts of information (digital libraries, archives, collections, etc.). The Internet is increasingly used in education and research to find information. At the same time, more and more duplicated and borrowed information appears. The same text documents (news, reviews, abstracts, articles) are completely or with minor changes moved from site to site, from one library or collection to others. Detection of copies of such documents (complete, partial or modified) becomes more relevant.

Methods of fuzzy duplicates detection

The task of complete duplicate texts detection solved quite simply. For example, checksums or hash codes that are counted across the entire text can be used and compared with similar codes of other texts. Much more difficult is the case with the search for overlapping texts (which are sometimes called fuzzy duplicates [1]). There are several approaches to the detection of fuzzy duplicates.

The most famous method was “shingles” [2]. The method based on the representation of texts as a set of sequences of fixed length, consisting of adjacent words. With a significant intersection of such sets of documents will be similar to each other. One of the modifications of the method, called the “supershingles”, is used to quickly detect such documents [3]. There are a number of methods that use signature lexical information of documents. The [4] uses the I-Match signature for these purposes, calculated for words with an average IDF (inverse word frequency in documents). Another signature-based approach based on lexical principles is the method of “description” words [5]. In this case, for documents, sets of reference words are compiled according to certain rules, for which document signatures are built. Coincidence of signatures speaks about the similarity of the documents themselves. This group of methods, despite the greater complexity of implementation, shows better results in finding similar documents [3].

For the detection of fuzzy duplicates, algorithms based on the classical principles of information retrieval, such as TF, TF*IDF [6], etc., are sometimes used. In [7] it is proposed to use the Jaccard similarity function, the use of which allows to achieve quite good results even in texts using synonyms and spelling errors. Algorithms based on suffix trees [8], N-grams [9], etc. can be used to find fuzzy duplicates.

Currently, quite a lot of systems have been developed to search for similar texts (plagiarism detection). Such systems as Antiplagiat, Advego Plagiatius, Copy-scape, Grammarly, PlagTracker, Turnitin, Unicheck are best known.

Despite the large number of existing solutions, none of them can serve as a universal means of detecting fuzzy duplicates. The main disadvantages of most existing approaches:

1. This is the focus of the search either on the Internet or on its own base. Obviously, a more accurate and universal check will be in the case of using both types of sources.

2. Most systems are not able to bypass the existing approaches to hiding traces of borrowing (to process the replacement of letters, remove signs of hyphenation, change endings, etc.).

3. The search area for fuzzy duplicates is most often limited to small texts of several thousand words. Systems are not adapted to work with large texts.

Most of the systems use the shingle method in their work. According to research [3], this method demonstrates the high accuracy of detecting duplicate texts. However, due to the nature of the implementation, the test results in each system are very different from others. The disadvantage of the method is the absence of the possibility of processing synonyms, since there are a large number of means of synonymizing texts. This is a significant disadvantage of existing systems.

To search for duplicates, either a limited collection of documents (which can be processed, indexed and placed in the search base) can be used, or the entire document space available on the Internet (a potentially unlimited collection that cannot be fully processed and placed in the search base in advance, before the inspection). For this reason, it is necessary to use two groups of algorithms:

1. Search for complete and incomplete duplicates in the search database,
2. Search for duplicates in the Internet.

The first group of algorithms is reduced to building an efficiently structured search base and developing search algorithms for it.

The second group is a big deal. The problem is that for small texts, the problem of finding fuzzy duplicates can be solved directly “head on” by searching in small pieces of text one by one. For large documents, however, a sequential search time in small chunks will be significant [10]. In addition, the number of calls to the Internet will be extremely high. In fact, it is necessary to search the entire space of the Internet for all documents containing a small piece of text from the document being checked, then select the next piece of text and repeat the procedure again until all the text has been checked. To solve this problem, it is proposed to use the following approach: for direct comparison of documents, the author suggests comparing not original documents, but their processed and filtered copies with the exception of non-informative objects, when comparing [11] (fig. 1). The comparison itself is proposed to be carried out along chains of words, calculating for it numeric signatures (hash codes) [12]. Comparison of a set of such signatures for texts will allow to evaluate the measure of their similarity (the more the signatures coincided, the more similar the texts).

To reduce the time for searching on the Internet, it is proposed to identify a set of key sentences on each page and compare texts on them (fig. 2). To determine the key sentences, an algorithm will be developed that takes into account the weights of words and sentences in the text. The use of the above approaches will allow to avoid the shortcomings of the existing analogues and to achieve high results in the detection of fuzzy duplicates of texts.

Conclusion

Thus, solving the problem of fuzzy duplicates detection is not an easy task. Its effective solution is possible with an integrated approach to finding duplicates both in local search databases and on the Internet. The main difficulty lies in reducing the number of queries to Internet search engines. For this, a method of identifying key sentences in the text is well suited.

Acknowledgment

The reported study was funded by RFBR according to the research project № 19-07-00692.

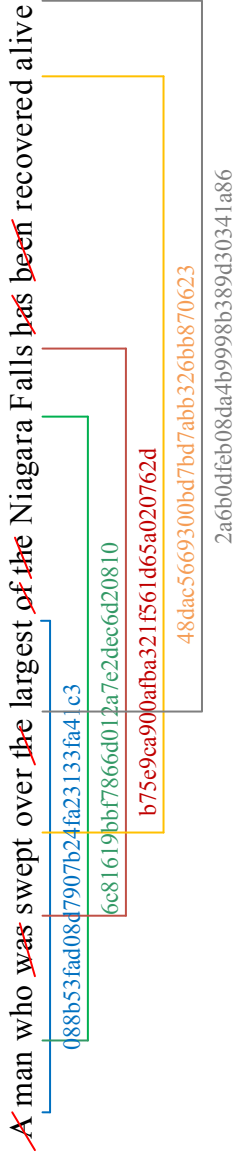

Figure 1. Filtered shingles

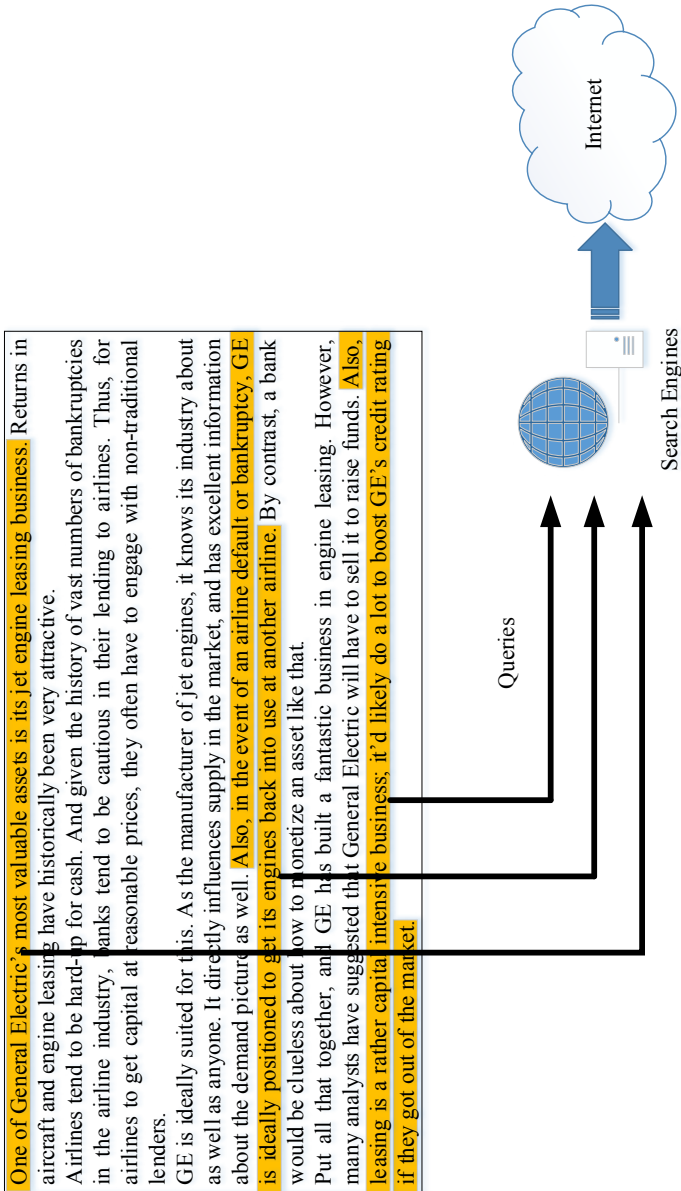

Figure 2. Key sentences of text

References

1. Sharapov R., Sharapova E. *The problem of fuzzy duplicate detection of large texts // CEUR Workshop Proceedings, 2018, vol. 2212. – P. 270-277.*
2. Broder A. *On the resemblance and containment of documents // Compression and Complexity of Sequences (SEQUENCES'97). IEEE Computer Society, 1998. – P. 21-29.*
3. Zelenkov Yu.G., Segalovich I.V. *Comparative analysis of methods for determining fuzzy duplicates for WEB-documents // Proceedings of the 9th All-Russian Scientific Conference "Digital Libraries: Advanced Methods and Technologies, Digital Collections" RCDL'2007. - Pereslavl-Zalessky, 2007. vol. 1. – P. 166-174.*
4. Kolcz A., Chowdhury A., Alspector J. *Improved Robustness of Signature-Based Near-Replica Detection via Lexicon Randomization // KDD 2004, 22-25 August, 2004, Seattle, Washington, USA.*
5. Ilyinsky S., Kuzmin M., Melkov A., Segalovich I. *An efficient method to detect duplicates of Web documents with the use of inverted index // WWW Conference 2002.*
6. Salton G., Buckley C. *Term-weighting approaches in automatic text retrieval // Information Processing & Management, 1988, vol. 24, n. 5. – P. 513-523.*
7. Neelova N.V., Sychugov A.A. *Comparison of results of detection of doubles by the method of shingle and the method of Jacquard // Vestnik RGTU. Number 4 (issue 34). Ryazan, 2010 – P. 72-78.*
8. Gusfield D. *Algorithms on Strings, Trees and Sequences. Cambridge University Press, 1997. – 556 p.*
9. Sidorov G., Velazquez F., Stamatatos E., Gelbukh A., Chanona-Hernández L. *Syntactic Dependency-based n-grams as Classification Features // Lecture Notes in Artificial Intelligence, vol. 7630, pp. 1–11, 2012.*
10. Chowdhury A., Frieder O., Grossman D., McCabe M. *Collection statistics for fast duplicate document detection // ACM Transactions on Information Systems (TOIS), 2002, vol. 20, issue 2. – P. 171-191.*
11. Sharapova E.V., Sharapov R.V. *System of Duplicate Texts Detection // CEUR Workshop Proceedings. Vol. 803. – P. 121-126.*
12. Fetterly D., Manasse M., Najor M. *A Large-Scale Study of the Evolution of Web Pages // ACM, 2003. – P. 669-678.*

解决血细胞图像上的白细胞分类任务
**SOLVING LEUKOCYTES CLASSIFICATION TASK
ON BLOOD CELL IMAGES**

Chernykh Evgeniy Mikhailovich,

bachelor,

Belgorod State National Research University

Belgorod, Russia,

Soynikova Ekaterina Sergeevna,

postgraduate student,

Belgorod State National Research University

Belgorod, Russia,

Mikhelev Vladimir Mikhailovich,

candidate of technical sciences, associate professor,

Belgorod State National Research University

Belgorod, Russia

抽象。该研究涉及血细胞图像上的白细胞或白细胞分类任务。寻找最可靠和有效的方法来解决这项任务多年来一直是一个重要的问题，因为有关人体血液中白细胞的信息包含重要数据，可用于评估人类健康，诊断患者或识别疾病。早期。作为该研究的一部分，研究了WBC（白细胞）对其两类 - 单核细胞和多核细胞的分类。研究的第一阶段致力于解决白细胞分类任务的问题，研究白细胞分类的现有和应用方法，并突出其缺点。为实现计算机系统，选择并研究了基于卷积神经网络的白细胞分类方法。对于应用程序的程序实现，使用了带机器学习库TensorFlow和Keras的Python编程语言。测试所实施的程序的结果显示出相对于大多数存在的白细胞分类方法的高表现。

关键词：白细胞；白细胞分类；计算智能；深度学习；卷积神经网络。

Abstract. *The research relates to the white blood cells or leukocytes classification task on blood cells images. Searching for the most reliable and effective way to solve this task has been an important problem for many years, because information about leukocytes in human blood contains an important data and can be used for assess human health, diagnose a patient or recognize the illnesses at an early stage. As part of this research WBC (white blood cells) classification with respect to its two classes – mononuclear and polynuclear cells was studied. The first stage of the research was devoted to the formulation of the problem of solving the leukocyte classification task, the existing and applied methods for leukocytes clas-*

sification were studied and its shortcomings were highlighted. For implementation of computer system, the leukocytes classification method based of the use of convolutional neural network was chosen and studied. For the program implementation of the application the Python programming language with machine learning libraries TensorFlow and Keras were used. The results of testing the implemented program showed high show high performance relative to the majority of existings methods for the white blood cells classification.

Keywords: white blood cell; leukocytes classification; computational intelligence; deep learning; convolutional neural network.

Introduction

Information about leukocytes that contained in blood - its total concentration and the ratio of the classes – is described by a leukocyte formula, the assessment of which in the hematological blood test provides information about the human health. The problem of solving a white blood cells classification task remains relevant today, since even small deviations in the leukocyte indicators can provide an important information about the state of human health. Determination of quantitative and morphological signs of leukocytes in blood is used to diagnose not only blood illness, a wide range of the other disease, but also to assess the functional state of human health.

The main purpose of the research is the creation of a computer systems that would allow to solve leukocytes classification task in blood cells images. To achieve this purpose, the following tasks were formulated, including: leukocytes data and their distinctive features review; review and analysis of the existing methods used for leukocytes classification; selection and studying of the theoretical foundations of the leukocytes classification method which the future computer system will be based on; design and program implementation of the computer system; conducting computational experiments and testing.

As a tool for a medical diagnostic, automated methods for leukocytes classification in blood cells images have been actively used for a long time [1]. The efficiency and accuracy of these methods is relatively high, but due to the wide variability of the cells, it's impossible to fully rely on the results obtained using these methods. The main common feature of these methods is the using of computer vision technology, which allows to automate the process of blood smear analysis.

So, G.V. Shtadelmann and I.N. Spiridonov gives an example of using the AdaBoost algorithm for leukocytes segmentation [2], which based on strengthen weak classifiers by combining them into the one strong. The presented algorithm for white blood cells segmentation consists of sequentially scanning the entire image with a window, which has a size that obtained based of the size of the largest type of leukocyte – monocyte. To exclude the re-detection of the same cells as a result of overlapping window positions, post-processing was performed by analyzing the distance between those window positions where the leukocytes were segmented.

V.K. Belyakov and others proposed a blood cells classification method with using an improved combined method of image segmentation, the feature vector of objects and a classifier based on an artificial neural network [3]. As the main evaluated features of leukocytes for the classification, in this method were proposed: the relative size of the segments and nuclei, as well as the minimum and maximum segment sizes; the ratio of the area of the nucleus to the area of the described rectangle; the moment of the boundary of the maximum nucleus and the coefficient of its shape; cell color characteristics etc. By using a multilayer artificial neural network as a classifier, the authors of the method managed to reduce the number of errors received on the test data set to 0.1%

It's easy to notice that the most accurate and effective classification method based on the using of the machine learning technology of artificial neural networks, which makes it important to use them as a tool for solving leukocytes classification task on blood cell images. Built on the basis of the functioning of the real biological structures of the nerve cells of the human brain, artificial neural networks allow to solve a wide class of problems: classification tasks, clustering, prediction, building dependencies, reducing the dimension of data, etc. Nowadays, this technology is actively used in medicine for processing and analyzing various medical images, as it eliminates the need to manually adjust parameters based on the object under study through the use of automatically trained models. The process of learning the model is based on the solutions of many similar tasks. Also, as a result of the appearance of a case of variability of initial data, artificial neural networks allow performing additional training without restarting and stopping the entire computer system.

Program implementation

In the late 80s of the last century, the architecture of convolutional neural networks was proposed, which was aimed at efficient image processing and reduction of computational loads [4]. Thus, the leukocyte classification method chosen in this research is based on the using of a convolutional artificial neural network, its training and further using to solve the leukocytes classification task.

Figure 1 illustrates a convolutional neural network model that was used for the software implementation in this research. As you can see, it consists of three pairs of convolutional layers and subsampling layers, as well as an ordinary fully-connected network, which contains two layers. While input image passes through the model layers, automatic identification of the distinctive features that form the feature maps is performed. At the subsampling stage, the output feature maps are compressed, after which the feature is re-highlighted on the compressed image. After the formation of the final feature maps, the obtained information is converted into a one-dimensional vector and sent to the input layer of a fully-connected network, which is a classifier.

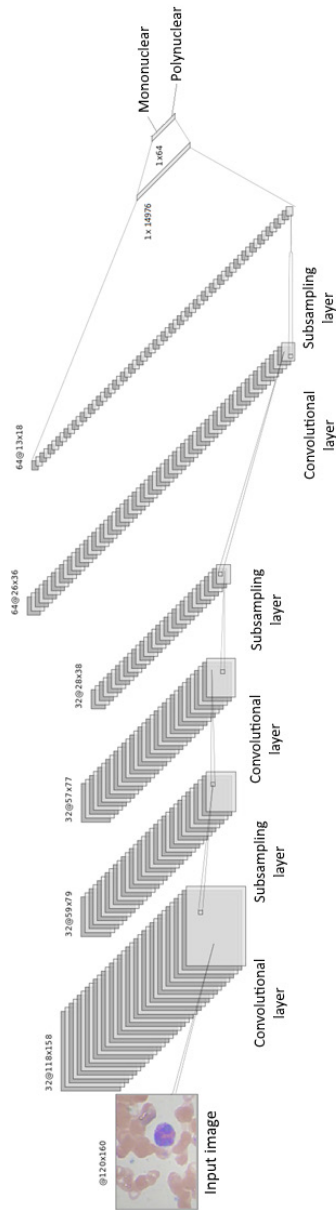

Figure 1: Used CNN model

In Figure 2, you can see how the features of each input image are highlighted. Inside the convolutional layer, an automatically formed convolution kernel is applied to the selected part of the image of a similar dimension. The figure shows how the view of the analyzed image changes as it passes through convolutional layers and subsample layers.

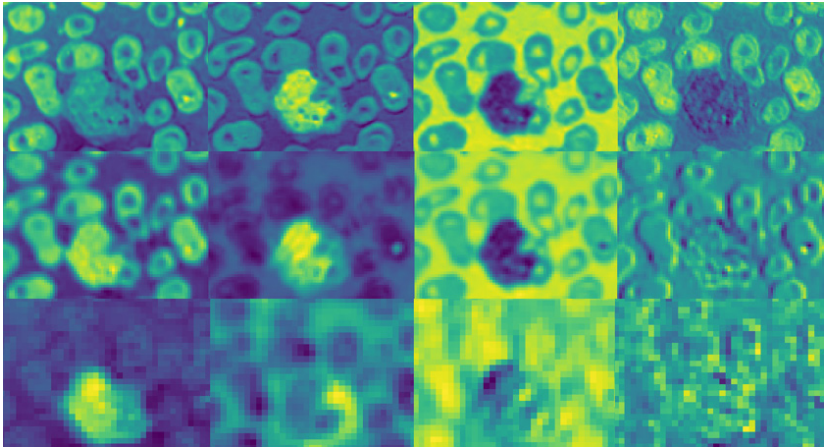

Figure 2: Input image conversion

The training of this model was carried out using a data set consisting of several thousand classified images of leukocytes. The duration of training was 20 epochs. To avoid the phenomenon of model retraining, the Dropout technique was used, allowing randomly disconnecting part of the neurons inside the layer.

The research results

The final result of this work is an application created with using the Python language and the Tkinter library, which allows to load and classify a leukocyte in a picture relative to its two classes — mono- and polynuclear cells, depending on the structure and shape of the leukocyte nucleus. In the process of the model training, the model's accuracy value increases, which can be seen in Figure 3.

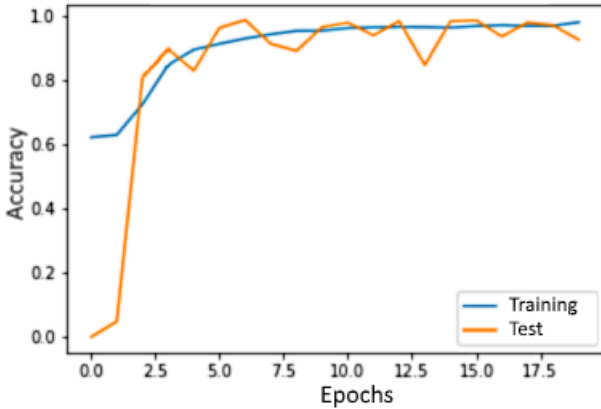

Figure 3: Obtained value of model accuracy

Figure 4 shows the window of the created computer system. During its initialization, the trained convolutional neural network model is loaded from a file, after which the program waits until the user selects and loads the image. When the image is loaded into the program, the stage of its classification begins, the result of which is displayed in the field of the lower window area.



Figure 4: Obtained value of model accuracy

For the data set used, the accuracy of the solving classification task was 97%, which is a fairly high result. This suggests that the created application can be used as a support tool in solving the white blood cells classification task in the hemato-logical blood analysis and speed up its implementation.

Acknowledgments

This work was supported by Russian Foundation for Basic Research (RFBR) grant 19-07- 00133–A

References

1. Kaiming, H. *Deep Residual Learning for Image Recognition [Text]* / Kaiming He, Zhang Xiangyu. – *IEEE Conference on Computer Vision and Pattern Recognition (CVPR)*, 2016.
2. Stadelmann, J.V. *Method for leukocyte formula determining [Text]* / Zh.V. Stadelmann, I.N. Spiridonov. - *Science and education. MGTU them. N.E. Bauman. Electronic journal* No. 10, 2012. Access mode: <http://technomag.edu.ru/doc/465287.html> (access date 07/07/2019).
3. *One method of blood cells classifying and its program implementation [Text]* / V.K. Belyakov, E.P. Sukhenko, A.V. Zakharov, P.P. Koltsov, N.V. Kotovich, A.A. Kravchenko, A.S. Kutsaev, A.S. Osipov, A.B. Kuznetsov / *Software Products and Systems-№ 4 (108)*, 2014. - p. 46-56.
4. Y. LeCun. *GradientBased Learning Applied to Document Recognition [Text]* / *LeCun Y.* – *Proc. IEEE* vol. 86 №11, 1998. – pp. 2278-2324.

环境, 光和重力波。 假设和建议

ENVIRONMENT, LIGHT AND GRAVITY WAVES. HYPOTHESES AND SUGGESTIONS

Sumachev Yury Nikolaevich

Metrology Engineer

Federal Budget Institution «Test-S. Petersburg»,

St. Petersburg, Russia

抽象。 本文基于空灵宇宙的范式, 讨论了光和引力波传播的原始思想和假设。 提出了测量光压, 以太相对于地球的运动速度和航天器绝对速度的方法。

关键词: 乙醚; 光; 重力; 速度; 测量; 空间。

Abstract. *The article discusses the original ideas and hypotheses of the spread of light and gravitational waves, based on the paradigm of the ethereal Universe. Methods are proposed for measuring of light pressure, the speed of movement of the ether relative to the Earth and the absolute speed of the spacecraft.*

Keywords: *ether; light; gravity; speed; measurement; space.*

The knowledge of the World, the study of physical phenomena, their laws and their correct explanation from a materialistic point of view are the main tasks of modern science. The materialists of ancient Greece created a coherent concept according to which “all natural diversity consists of the smallest particles of matter, from atoms that move, collide and combine in **empty space**” [4, p. 13]. Newton, formulating the law of world wideness, did not allow the possibility of the spread of interaction in empty space. “Therefore, he, like Huygens, assumed that there is a special substance - **ether**, which fills all the space between the bodies. It is through this ether that one body acts on the other” [3, p.133]. “In optics, the ether acted as a necessary carrier of light waves, and in mechanics it appeared as a preferred frame of reference, i.e. made it possible to establish the presence of absolute motion or an absolute reference system ”[4, p.62]. Modern physics rejects ether and absolute space.

Einstein formulated the basic physical principles on which his theory is based: the constancy of the speed of light in a vacuum, the hypotheses about the geometric nature of gravity and the relationship of the geometry of four-dimensional space-time and matter. “However, physicists, following Einstein, chose to aban-

don the ether and go to the space **vacuum** and **the space-time continuum** that does not exist in objective physical reality, and physics was replaced by abstractions of geometry and mathematics, so physics went from materialism to idealism” [2, p.192].

E.N. Avdeev, critically analyzing the concepts generally accepted in modern physics, writes the following. “Intangible space and time, which exist only as certain concepts, ideal representations in the human mind, belong to the world of ideas, and not to the material physical world. Being intangible, space and time cannot influence the physical world and be the causes of physical phenomena. Space and time is something that does not exist in the real physical world in the form of material formations, and that which does not exist, cannot have geometrical properties, can neither bend, nor contract, nor accelerate, or slow down” [2, p.10]. Any critical analysis of a scientific theory that reveals its problems and mistakes, its false statements and conclusions, or a wrong explanation of the physical World, allows us to get rid of errors and acquire new knowledge.

Deepening the essence of physical phenomena and the physical laws reflecting them inevitably leads to the conclusion that the environment of the Universe exists. The aetheric theory claims that all world space is filled with an active material medium — the ethereal gas, and gravity, inertia, light, material bodies, elementary particles, force fields — all are manifestations of the aether, like particles of primary matter and the material basis of the universe. Particles of ether are the deepest level of the structure of matter. The size of ether particles is 15–20 orders of magnitude smaller than the size of elementary particles, for example, an electron. According to the author’s hypothesis presented in article [7, p. 26], the ether particle is one-dimensional structureless, i.e. fundamental particle, the only form of existence of which is variable mechanical motion. The ether was formed before the Big Bang. The vortex seals of the ether with a dense central core are elementary particles of ordinary matter, of which all matter consists. In any small volume of space there is a large number of these energy-related particles, sufficient to consider the medium continuous. “Ether, as a material medium, has the properties of an ideal gas and should be characterized by the following parameters: density, pressure, temperature, speed of translational or rotational motion” [5, p.17]. The ether is inaccessible to our senses and direct instrumentation observation, therefore it can be detected only indirectly by force manifestation, after conducting a logical analysis of a physical phenomenon. The cause of the movement is only the matter itself, directly or through the surrounding material environment.

Avdeev E.N. this explains the nature of gravity: “The acceleration of free fall is caused by the movement of the ether to the body as a sink, in which the cross section of the ether decreases as it approaches the body, causing an increase in the velocity of its influx to the body. Hence the inversely proportional depend-

ence of the acceleration of free fall on the square of the distance from the body. The acceleration of the ether is transmitted to all bodies and elementary particles. This creates a force of aggression. Obviously, the strength of the gravitational coefficient should be reflected in the law of the world, depending on the density of the ethereal medium. The gravitational coefficient is inversely proportional to the density of the ether. The density of ether in outer space is greater than the density at the surface of the body” [2, pp. 162-163]. As penetration into the body, the speed of ether decreases linearly to the center of the body, giving it kinetic energy and heating the body.

Modern physics denies the luminiferous medium, but how can electric and magnetic fields arise in a physical vacuum - a continuum devoid of charges and currents? The quantum of radiant energy is identified in modern theory with a photon - a pointless particle without mass, which is considered to be the carrier of the fundamental interaction. And, nevertheless, this elementary particle can have different energy, impulse, spin, can have a dynamic mass and actively interact with matter. When light propagates in interstellar space over vast distances, the photon moves at the speed of light relative to vacuum from one part of the Universe to another for millions and even billions of years. How can a point quantum object, a photon, have a wavelength, sometimes measured in kilometers? All this casts doubt on the officially accepted structure of the photon. Moiseev B.M. writes that “so far light is one of the darkest concepts of physics” [6, p.122]. Sometimes on the way of knowing the World, it turns out that some facts or laws are not clear and are in conflict with existing ideas, then a hypothesis is put forward explaining the observed discrepancy. The scientific hypothesis needs to be checked for its validity.

The aim of the article is to propose, without contradicting any of the fundamental laws of physics, original hypotheses and ideas of new targeted experiments confirming the existence of the ether. In addition, to offer solutions to some problems of absolute space and try to explain some physical phenomena, such as light and gravitational waves, based on the paradigm of the etheric Universe.

There are many similarities in Nature and you just need to understand the physical essence of the phenomenon and see the differences. In my view, light quanta emit excited atoms of matter when electrons transfer from one orbit to another with a lower energy. Electrons, as material particles, have a mass and an electric charge. The transition of an electron from one orbit to another occurs with variable acceleration. The rapid change of position in space of an electric charge excites transverse electromagnetic waves in the environment, which propagate in this medium. The phase velocity of light propagation is determined by the parameters of the resonant system of an open environment, which includes elasticity (electrical permeability) and inertia (magnetic permeability). The wavelength is

determined by the distance between the orbits and the electron transition time. At the same time, the mass of an electron during its accelerated motion excites a mechanical impulse of force acting on the ether medium, causing longitudinal mechanical oscillations in it. The speed of propagation of mechanical vibrations may differ from the speed of light, depending on the parameters of the medium, such as density, elasticity, pressure, etc.

Thus, atoms emit light quanta of two types of energy - electrical and kinetic (the duality of light) and do not emit any corpuscles of unknown physical nature. If there is a medium, then when it is excited, no transfer of particles of the medium is required, which are elastically connected by charges with each other. The medium in this case is only a carrier of energy. In the case of sound, when particles of gas or water oscillate near the sound source within the length of the longitudinal wave, the mechanical pulses of sound pressure in the medium are transmitted to a distance with the speed of sound. The phase velocity of sound propagation is determined by the mechanical parameters of its resonant system, which includes elasticity (compressibility, stiffness) and inertia (density, mass). For the propagation of sound in the medium, no interaction carriers are required. The speed of sound is constant in the propagation medium and does not depend on the speed of the source. Similarly, the light propagates in the ether medium without transferring any particles of matter, and electric fields arise when the medium is polarized during its excitation by transverse oscillations. Electromagnetic waves of excitation of the ethereal medium with energy transfer “propagate in space with a constant speed relative to the medium, independent of the speed of the light source” [6, p. 383].

The radiation pressure of the light flux was discovered experimentally in 1899 by the Russian physicist P.N. Lebedev. The fact that a mechanical impulse is associated with an inert mass of light has been established and accepted by science. With a constant light flux, this pressure is constant, and this pressure is of the same nature as gravity, i.e. creates a gravitational field. If the light flux is modulated with a low frequency, then the light pressure will be variable, that is, longitudinal mechanical oscillations will occur that can be sensed, for example, by a microphone or by a piezoelectric pressure (force) sensor. These longitudinal vibrations of the ether medium are gravitational waves. When exploring outer space to detect and receive gravitational waves, such as those arising from supernova explosions or other catastrophic events, I suggest placing narrowly spaced microphones with a large membrane area in telescopes together with telescopes. Natural gravitational waves of ultralow frequencies are known in Nature, which arise on the surface of the Earth during its daily rotation in the gravitational fields of the Moon and the Sun. The greatest modulation of gravitational fields occurs when the distance between the Moon and the Earth's surface changes, which leads to the ebb and flow

of water in the oceans, to the displacement of Earth's tectonic plates, to increased volcanic activity, etc. Artificial gravitational waves, which can cause mechanical oscillations of microparticles and molecules in material bodies, heating them, possibly, arise with microwave radiation.

To study the effect of pressure of light emission in the Metrological Department of Radio Engineering, Vibration and Acoustic Measurements, a test experiment was conducted using the Type 4145 condenser microphone and several light sources in the FBU Test-S.-Petersburg. The signal level was measured by a Type 2610 amplifier with a Type 1617 filter. A 13.5V incandescent bulb and a 14V white LED were used as radiation sources. An alternating voltage of about 7 V with a frequency of 2.5 Hz was applied to the bulb in order to obtain the greatest amplitude of the light signal with a frequency of 5 Hz of sinusoidal shape. The lamp was placed at a distance of about 15 mm from the open membrane of the microphone.

The structural scheme of measurement is shown in Fig. 1.

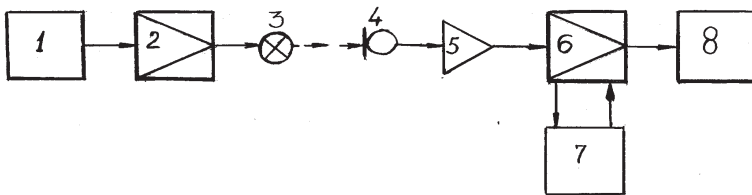

- 1 - Generator; 2 - power amplifier; 3 - light source; 4 - condenser microphone; 5 - microphone amplifier; 6 - measuring amplifier; 7 - filter; 8 - oscilloscope

Fig.1 Measurement of variable light pressure

The measured signal level is 50mV (approximately one Pascal). With an increase in the light supply frequency up to 40 Hz, the light signal and the measured level decreased several times, which is due to the inertia of heating and cooling the filament of the light bulb. The same measurements with the LED showed that the level of the measured signal at a frequency of 2.5 Hz is about 10dB less, but the drop in the signal level occurs in a wider range (up to 1 kHz). The overall decrease in the measured voltage level for all radiation sources (approximately 10dB per octave) is probably due to the inertness of the ether medium during the generation of longitudinal oscillations of gravitational waves.

Speed - one of the characteristics of movement is a value equal to the ratio of the movement of the body to the corresponding time interval. The speed allows to compare in relative units relative motion only between bodies (reference systems), relative to the environment or either some generally accepted absolute reference system, which is chosen as the "stationary". The theory of relativity considers all

inertial reference frames to be equivalent, since any of them can be chosen fixed. A. Einstein asserts with his first postulate the impossibility of detecting absolute movement and, of course, absolute rest. He also postulates the constancy of the speed of light in a vacuum and its independence from the speed of the source, without specifying what the value of the speed of light and its constancy is determined about. Since, according to the theory, the environment is absent, the speed of light cannot be determined relative to vacuum, neither source nor receivers.

It is definitely necessary to recognize that the speed of light is constant in the environment, i.e. on the air, and independent of the speed of the source or receivers (observers). Doppler change in the frequency of light depends only on the relative speed of movement between the source and the receiver. For light, ether is an absolute reference system. Presumably the speed of the aetheric stream at the surface of the Earth is equal to the second cosmic velocity. Therefore, the speed of light in the direction of the Earth should increase, and from the Earth - decrease. To confirm this phenomenon, I propose the idea of an experiment. The level of development of modern technology allows it. On the surface of the Earth and on the spacecraft (satellite) it is necessary to establish the exact clock, source and receiver of light. The timing of the signals must first be checked. It is necessary to measure in turn the time of passage of signals from the satellite to the Earth and back from the Earth to the satellite. It is desirable that the satellite was at an altitude of about 30000km or more. The functional diagram for measuring the velocity of the ether in the gravitational field of the Earth is shown in Fig. 2. In the considered case, the speed of the ether medium in the direction of the Earth will be average, since at the height of the satellite, the speed of the ether is less than that of the Earth's surface. The velocity of the medium is calculated by the formula: $V_{cp} = c (t_1 - t_2) / (t_1 + t_2)$, where c is the speed of light in a stationary medium (300000km / s), t_1 and t_2 is the time of the signal from the source to the receiver.

To measure the speed of the ethereal medium of outer space, it is necessary, as was suggested earlier, to measure the speed of light signals in the forward and opposite directions between two spacecraft. Devices must be located at a distance of several thousand kilometers from each other and move at the same speed (the distance is measured by radar, and the control of the coincidence of speeds - by the absence of the Doppler effect). The speed of the medium will be measured relative to the apparatus and equal to the speed of light in relation to the difference in measured times to their sum. The speed of the apparatus will be absolute if we take the ether medium as an absolute reference system.

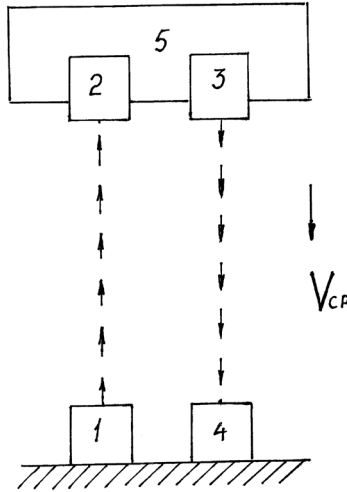

1 and 3 - the light source; 2 and 4 - light receiver; 5 - spacecraft.

Fig.2 Scheme of measuring the speed of ether in the gravitational field of the Earth

The mathematical concept of a **coordinate system** only after being tied to a certain physical object becomes a physical **reference system**. Causes the complexity of measuring speed in space. In space, it is necessary to measure the speed of the ether medium or spacecraft relative to the absolute reference system - outer space, which is associated with the location of stars and galaxies. For an observer, distant stars appear to be motionless, and their mutual position in the starry sky has not changed for thousands of years. I propose the idea of an optical device on board a spacecraft to directly measure its absolute speed of movement [8]. The conditional diagram of the measuring device is shown in Figure 3.

The device contains two (or more) identical optic tubes 1 and 2, installed parallel to each other at a fixed distance L and perpendicular to the direction V of the ship.

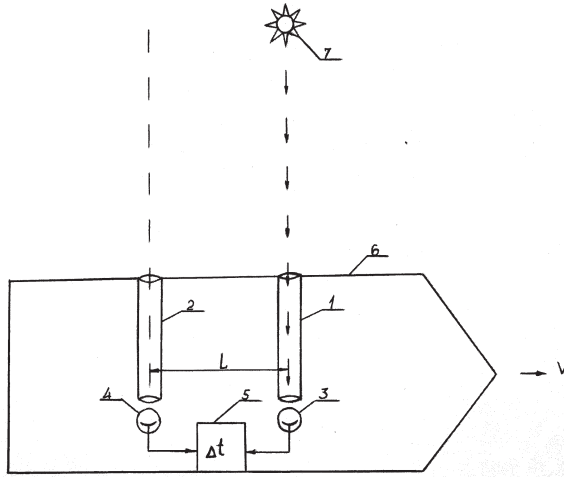

Fig.3 Device for measuring the speed of a spacecraft

At the ends of the tubes, photosensitive elements 4 and 5 are installed, the outputs of which are connected to the electronic unit 5. The entire device is housed in the hull of the ship 6 so as to be able to observe the light of a star 7. The telescopes are formed using the built-in optics (or mask) narrow field of view. To ensure the necessary measurement conditions, the device can be additionally equipped with orientation, adjustment and correction technical means. The stellar background of outer space is used as the absolute reference system.

When the spacecraft moves, the telescopes are directed in parallel to different narrow sections of the starry sky and, when the light of the far star enters the field of view of the tube 1, the photocell 3 forms the first electrical impulse. Upon further movement of the ship, the light of the same star enters the field of view of another tube 2 and the photocell 4 forms the second pulse. Then, in the electronic unit 5, the duration Δt between them is determined by the front or rear edges of the pulses. The speed of the ship V is defined as the ratio of the distance between the telescopes to the duration between the pulses, i.e. during the time during which the ship will move a certain distance from one point of space to another, and is remembered in the electronic unit. As the following stars get into the device's field of view, the following instantaneous velocity measurement results will be obtained. This speed of the ship is absolute, since measured relative to the reference frame associated with the outer space of the universe. Knowing the absolute speed of the spacecraft and its speed relative to the ether medium, it is possible to calculate the absolute velocity of the medium.

The measurements of the pressure of light and the speed of the ether proposed in the article will additionally confirm that the ether medium exists and may require its deeper study and revision of certain branches of physics. The proposed method and device for measuring the speed of spacecraft can help in further scientific exploration of space. Science in its essence should be materialistic, on the basis of which it is possible to build a physically realistic, devoid of subjectively idealistic mysticism, ether theory. I hope that among curious readers and researchers of physical phenomena hypotheses and ideas proposed in the article will arouse interest in finding the right answers to the riddles of Nature.

References

1. Avdeev E.N. *Alternative Physics: The theory of absoluteness and ether*. - Moscow: LENAND, 2015, - 352 p.
2. Avdeev E.N. *Errors and delusions of modern physics (the theory of relativity and the classical theory of aggression)*. - Moscow: LENAND, 2018. -200 p.
3. Aleshkevich V.A. and others. *The course of general physics. Mechanics*. – Moscow: FIZMATLIT, 2011, - 472 p.
4. Akhundov M.D. *Space and time in physical knowledge*. - Moscow: Thought, 1982. – 253 p.
5. Bukhalov I.P. *Physics of inertia and gravity. Ed. 2nd, isp. And add.* Moscow: Book house “LIBROCOM”, 2009, -244 p.
6. Moiseev B.M. *Fundamental physics, its philosophy and common sense: Compatibility analysis*. - Moscow: LENAND, 2017. - 432 p.
7. Sumachev Yu.N. *Big bang or small? The beginning of the evolution of the universe*. - *Electronic periodical scientific journal “SCI-ARTICLE.RU”*, 2015, No. 24, - 19 - 28 p.
8. *Optical speed meter: Pat. Of the Russian Federation No. 2686515 Yu.N. Sumachev; declare 09.18.2017; publ. 04/29/2019 Byul. №13.*

科学出版物

上合组织国家的科学研究：协同和一体化

国际科学大会的材料

(2019年7月12日 中国北京)

编辑A. A. Siliverstova

校正A. I. 尼古拉耶夫

2019年7月16日 中国北京。格式60 x 84/ 16。
USL。沸点：98.7。 订单259. 流通450份。

在编辑和出版中心印制
无限出版社

